



Datsun 240z

Scale 1/4

Specs :

1. Length : 1030mm / 40.5 inches
2. Width : 455mm / 17.9 inches
3. Wheel : 160mm / 6.3 inches
4. Wheelbase : 610mm / 24 inches
5. Weight : 2840 grams/ 100.1 oz
6. Drivetrain : Rear-wheel drive

Electronics

- 3536 1200kv - 650kv Brushless motor
- 50A ESC
- Battery Lipo 3S 2200mah
- 1x Standard servo
- 4x 9 gram servo (micro)
- 20x 5mm blinking LED (yellow)
- 2x 12v LED single LED (white)
- 50 cm 12v LED stripes (white)
- 3v Step down
- 7x limit switch (micro)

Materials :

1. 5mm Foamboard/ Depron/ Polyfoam
2. 3mm Plywood / PVC foam board
3. 0.3mm Mica Plastic
4. hot glue, UHU glue, CA glue
5. packing tape/ laminating film

Build Instructions :

1. paper-replika.com
2. youtube channel : Julius Perdana

W1

WHEEL SPOKE
PLYWOOD 3MM
4X



W2

TIRE
EVA FOAM 10MM
4X

W4

RIM
MICA PLASTIC
4X

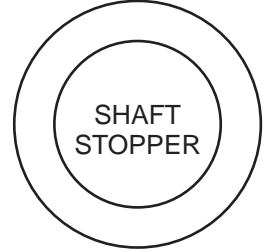
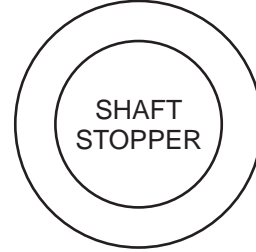
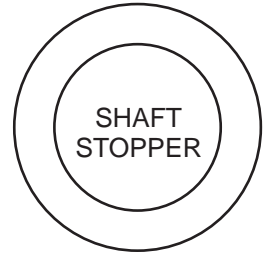
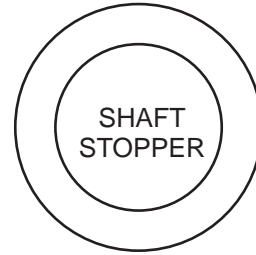

JOIN HERE

JOIN HERE

JOIN HERE

W2

JOIN HERE

W4

W5





W3

TIRE
EVA FOAM 10MM
8X

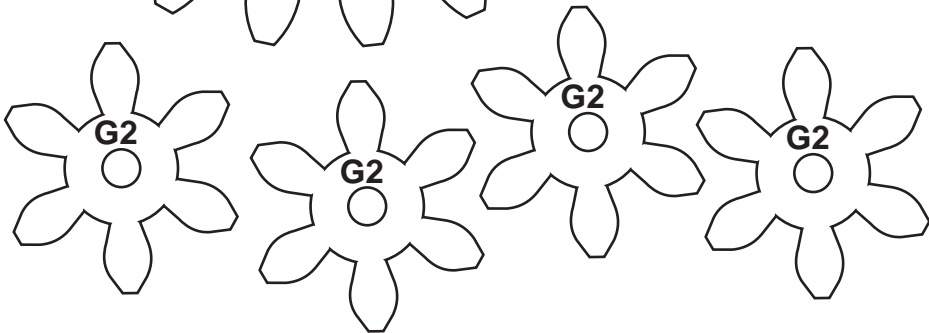
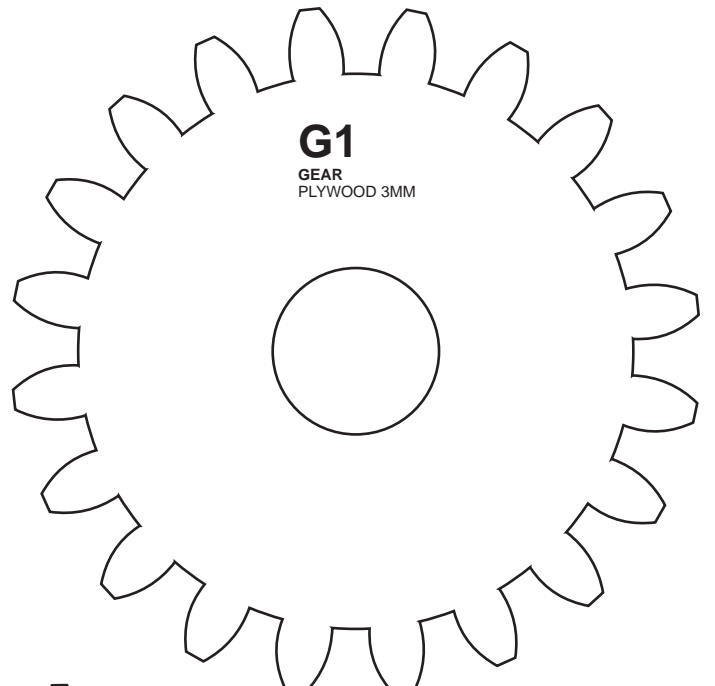
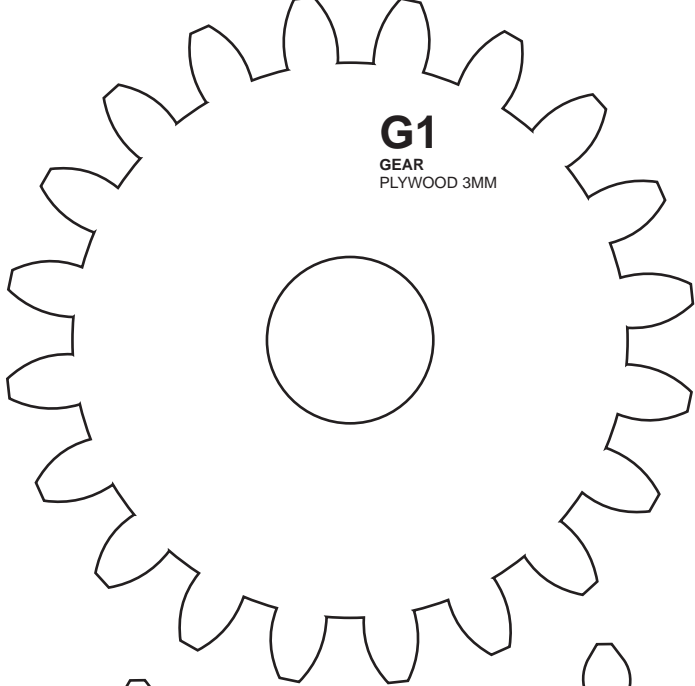
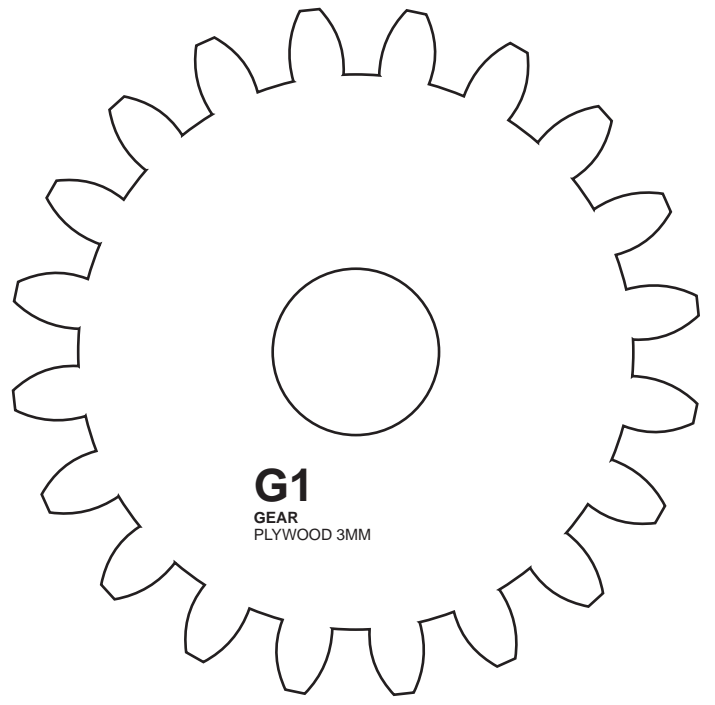
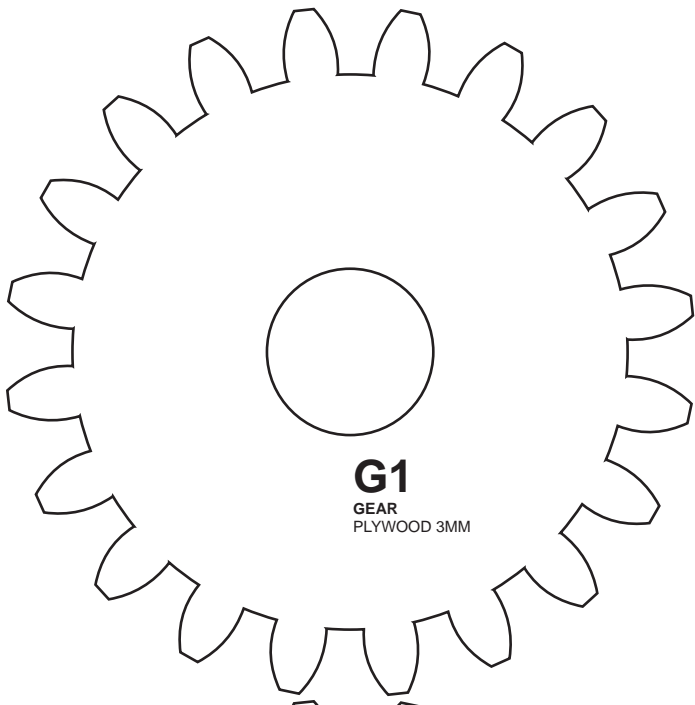

JOIN HERE

JOIN HERE

C1
CHASSIS
PLYWOOD 3MM +
DEPRON 5MM

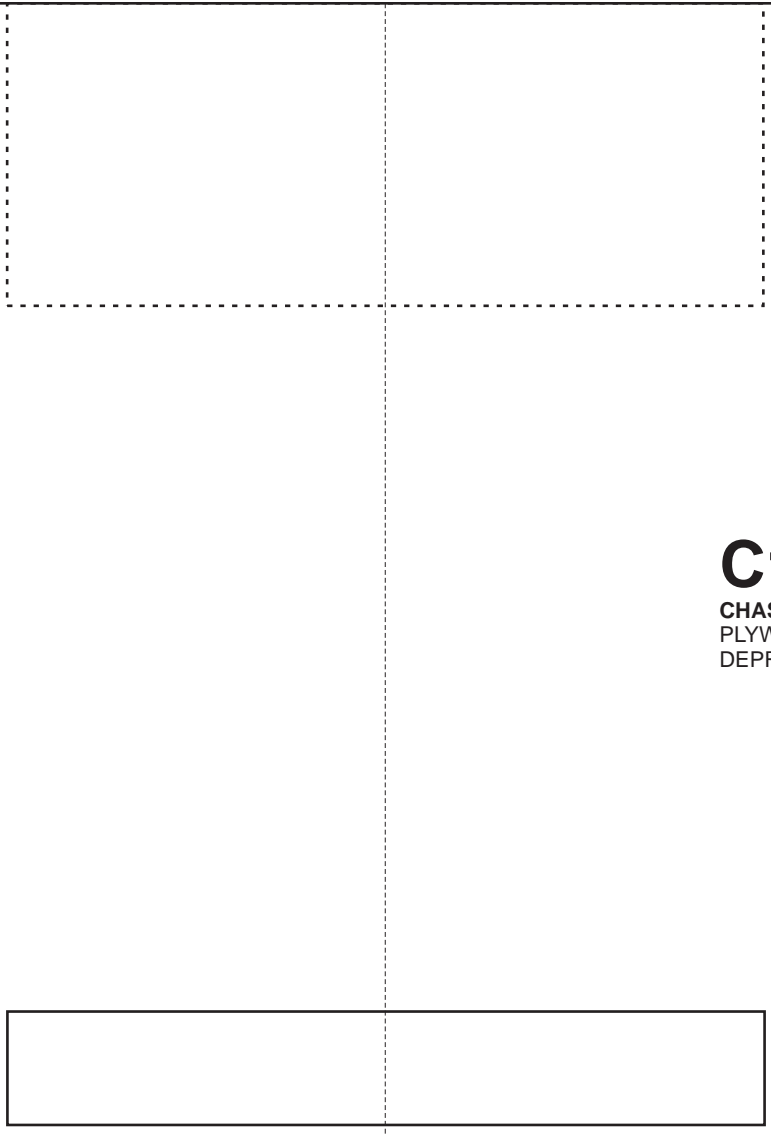

JOIN HERE

JOIN HERE

C1

JOIN HERE

JOIN HERE

C1

JOIN HERE

JOIN HERE

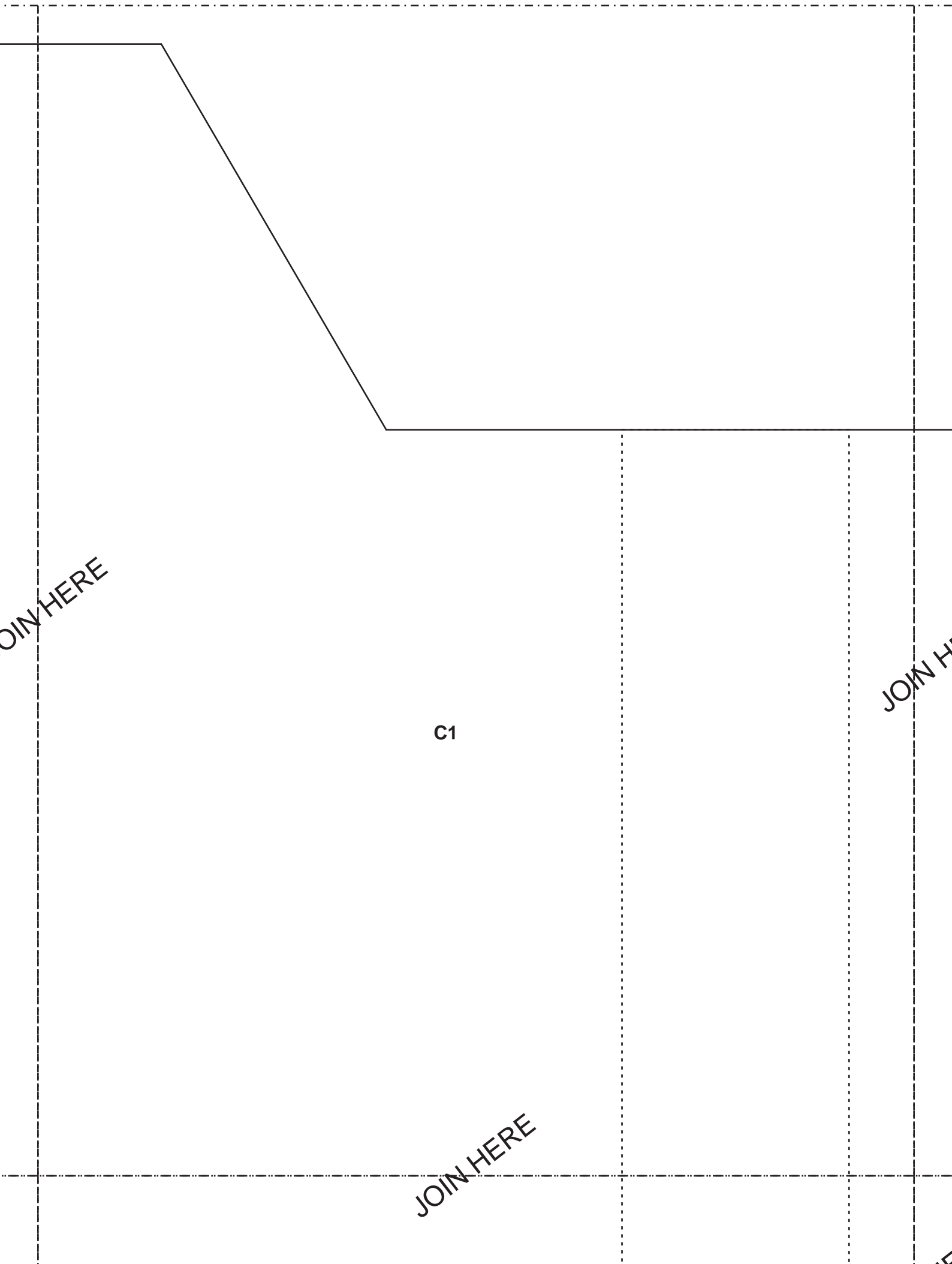

JOIN HERE

C1

JOIN HERE

JOIN HERE

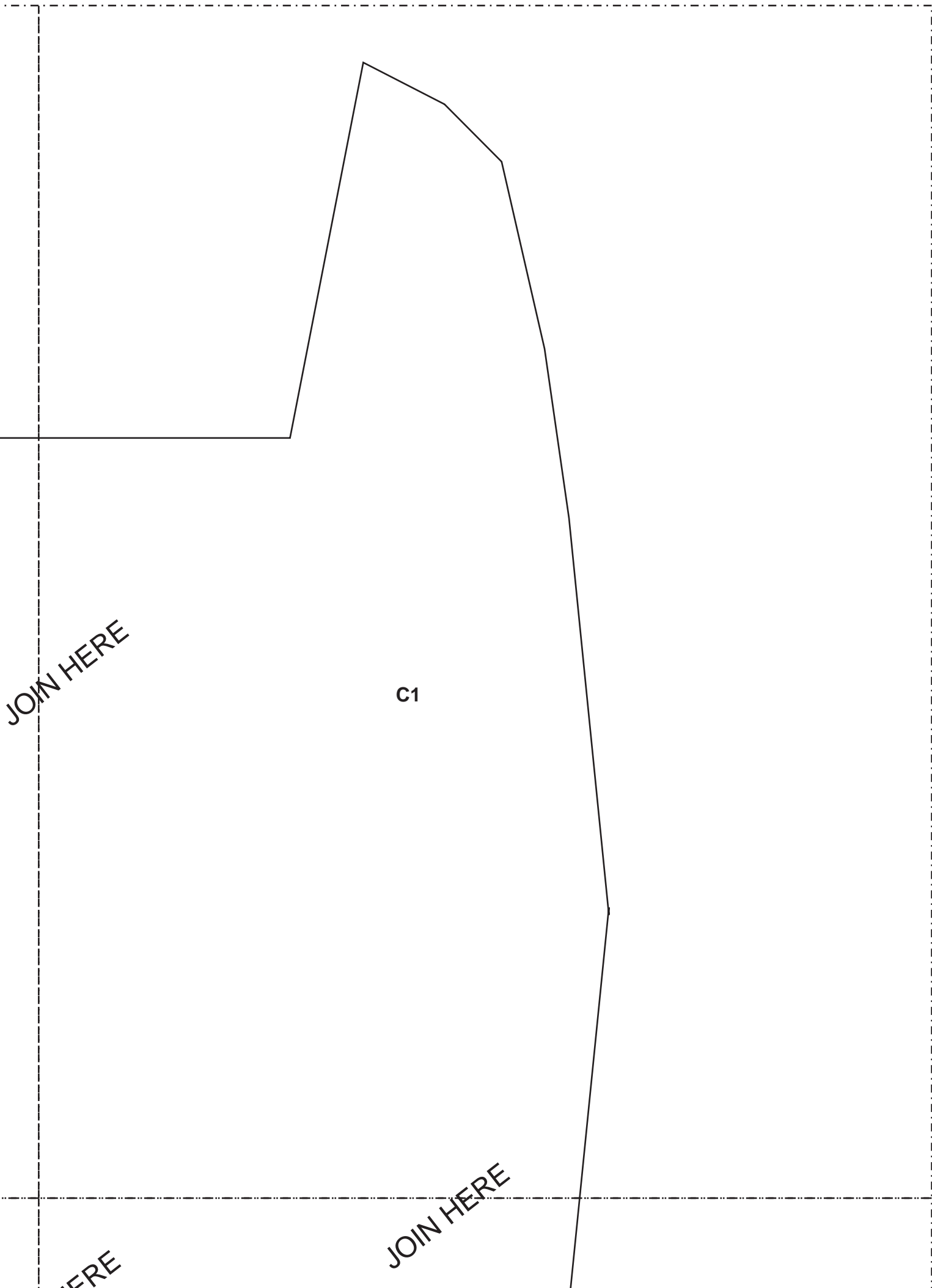

JOIN HERE

C1

JOIN HERE

HERE

JOIN HERE

C1

JOIN HER

C2

CHASSIS
PLYWOOD 3MM

C2

CHASSIS
PLYWOOD 3MM

JOIN HERE

JOIN HERE

C1

JOIN HERE

JOIN HERE

C1

JOIN HERE

JOIN HERE

JOIN HERE

C1

JOIN HERE

JOIN HERE

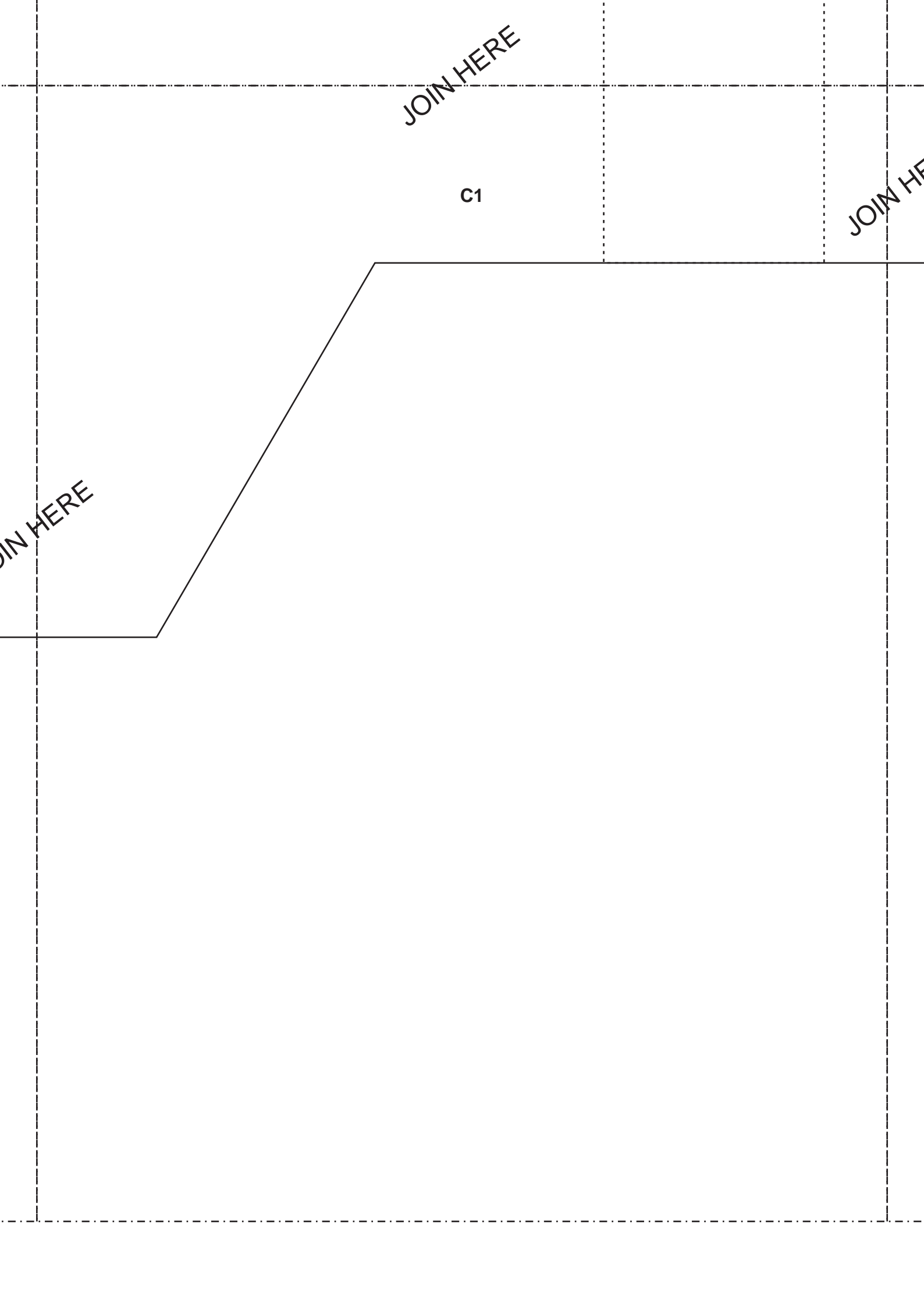

JOIN HERE

JOIN HERE

C1

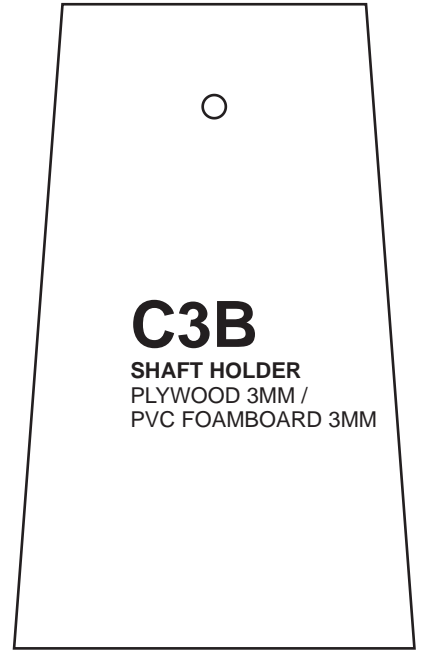

C3B

SHAFT HOLDER
PLYWOOD 3MM /
PVC FOAMBOARD 3MM

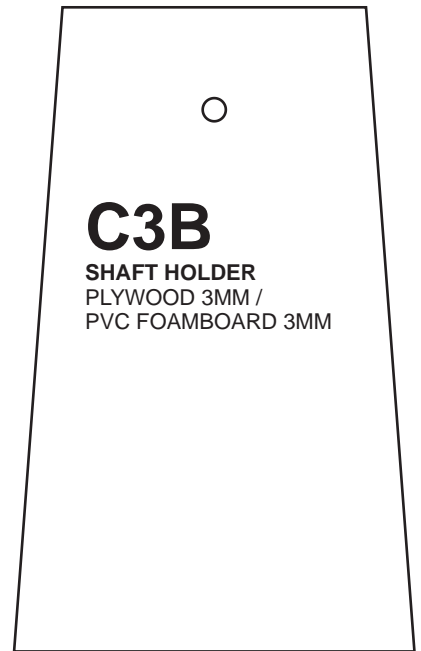

C3B

SHAFT HOLDER
PLYWOOD 3MM /
PVC FOAMBOARD 3MM

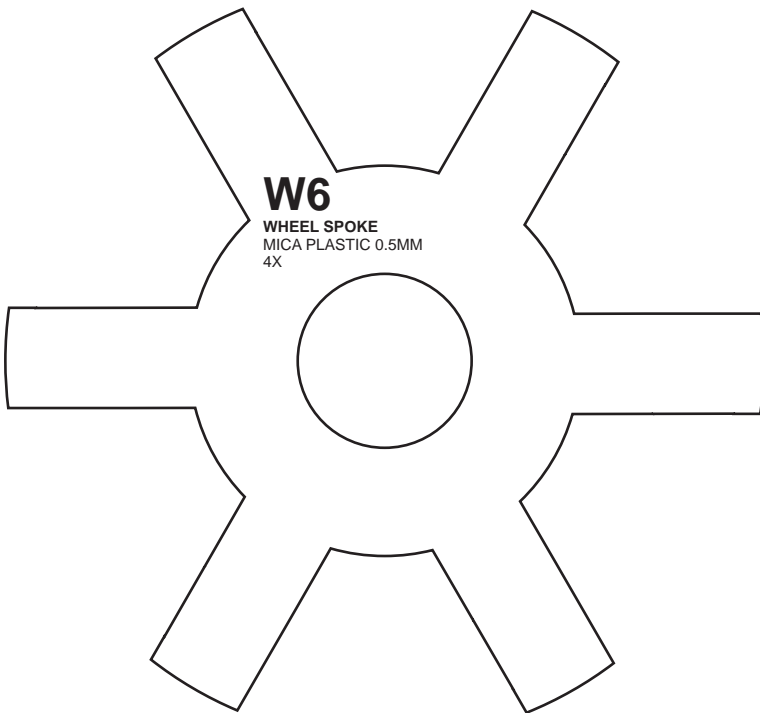

W6

WHEEL SPOKE
MICA PLASTIC 0.5MM
4X

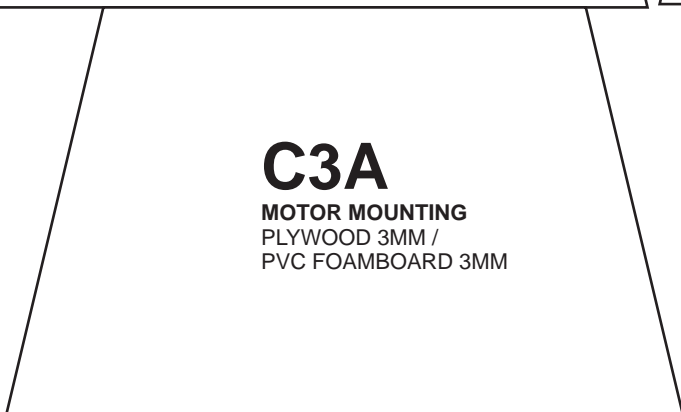
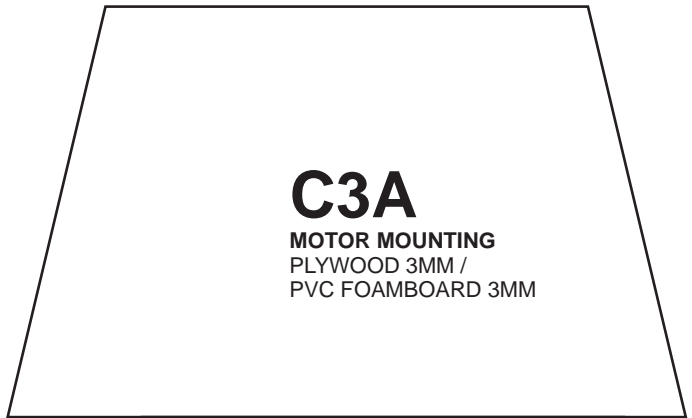
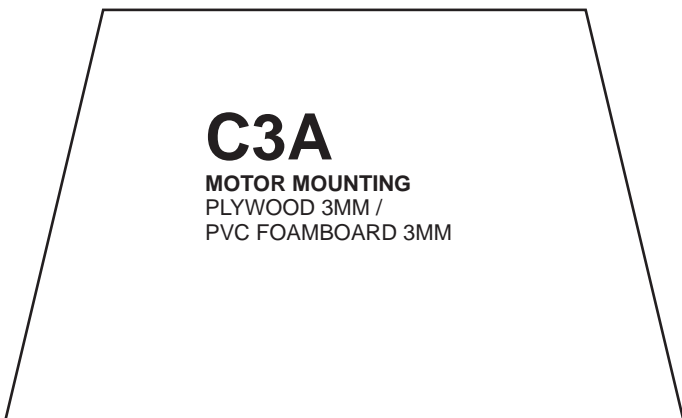
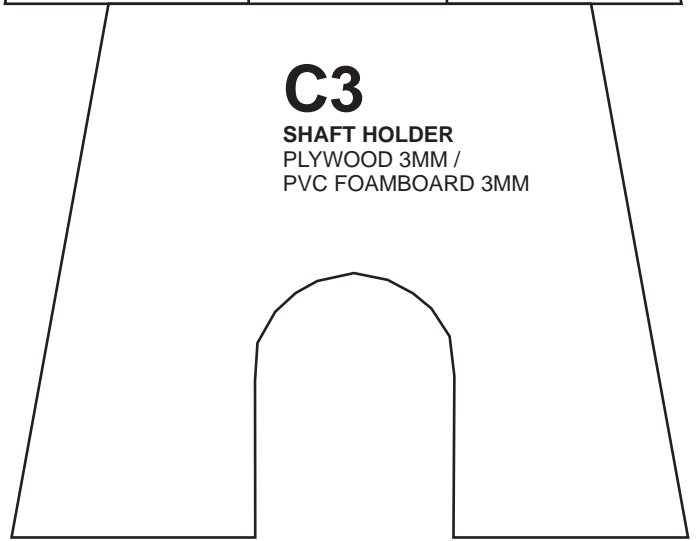
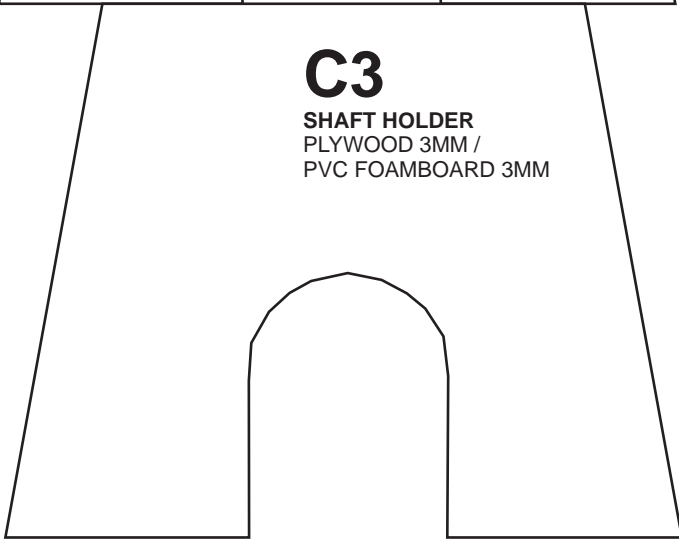
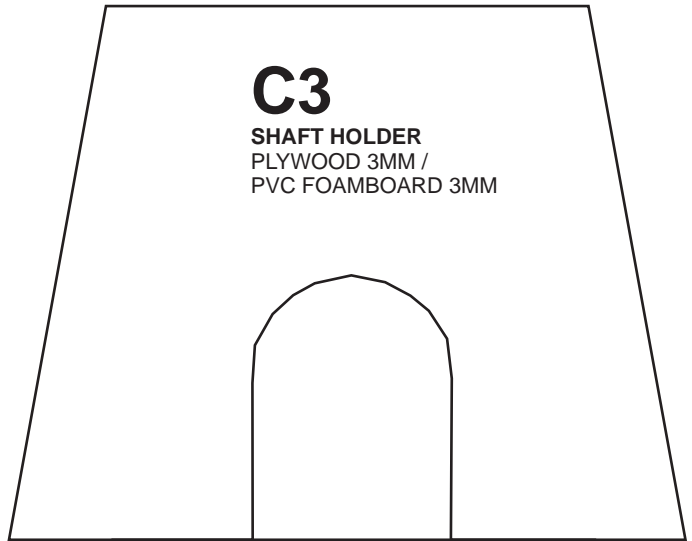
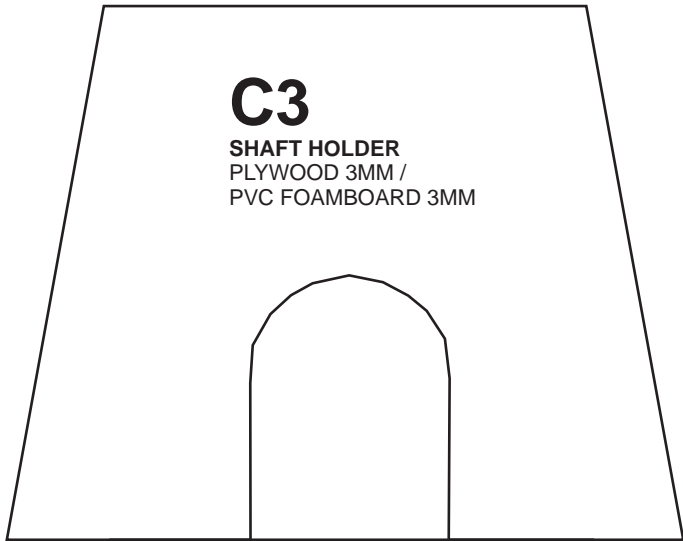

C4

STEERING SET
PLYWOOD 3MM /
PVC FOAMBOARD 3MM

JOIN HERE

C4

STEERING SET
PLYWOOD 3MM /
PVC FOAMBOARD 3MM

C4

STEERING SET
PLYWOOD 3MM /
PVC FOAMBOARD 3MM

JOIN HERE

C4

STEERING SET
PLYWOOD 3MM /
PVC FOAMBOARD 3MM

JOIN HERE

C5

STEERING SET
PLYWOOD 3MM /
PVC FOAMBOARD 3MM

JOIN HERE

C5

STEERING SET
PLYWOOD 3MM /
PVC FOAMBOARD 3MM

JOIN HERE

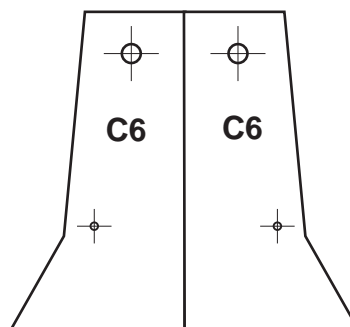
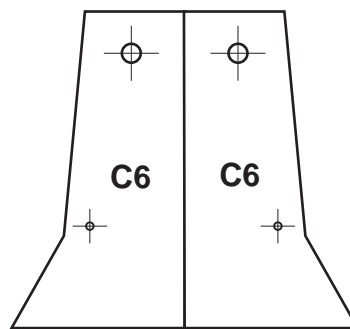
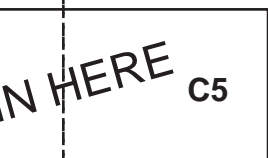
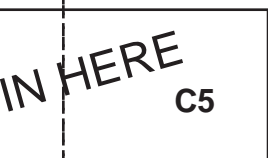
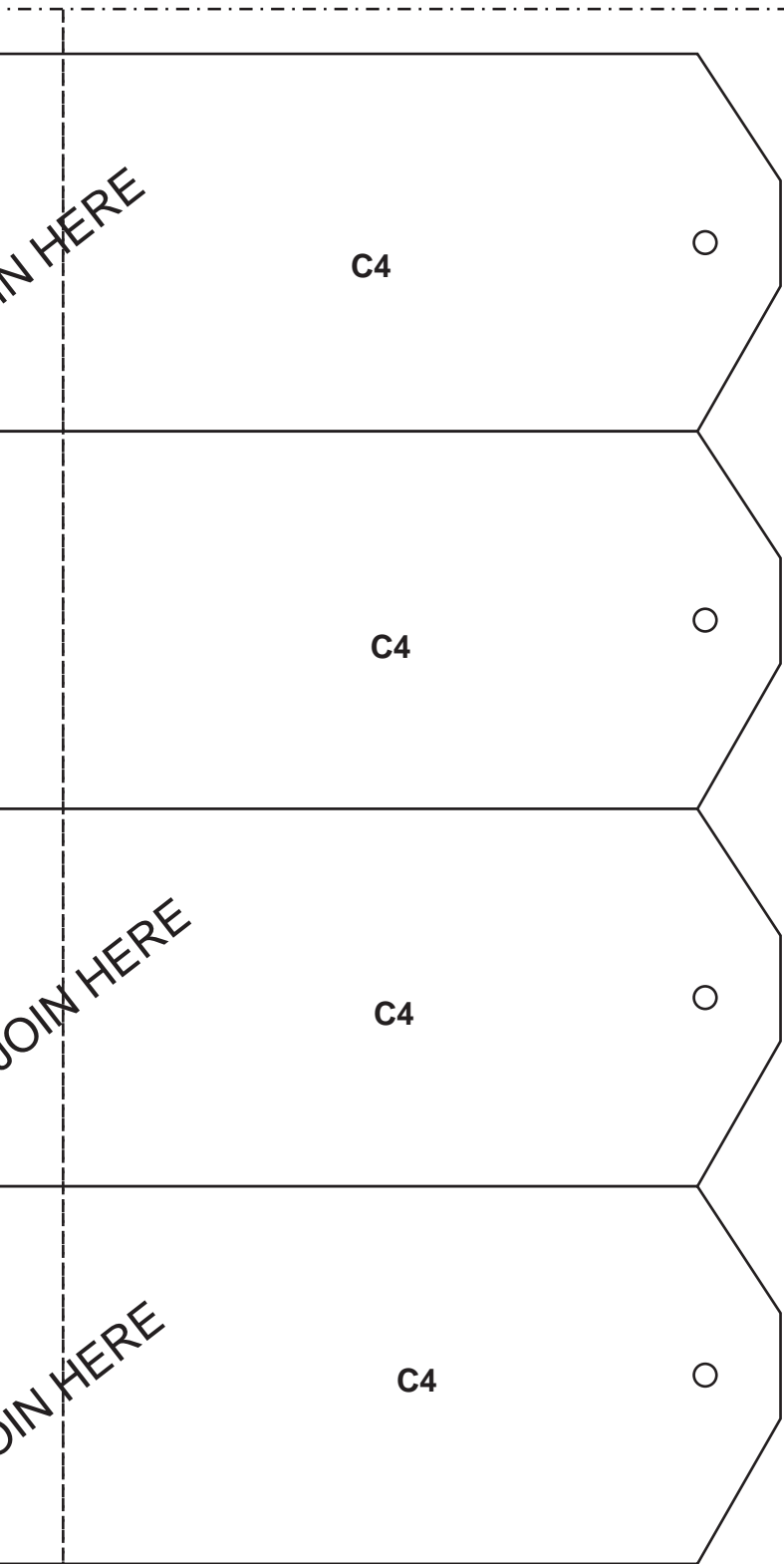



G3
GEAR
PLYWOOD 3MM



G3
GEAR
PLYWOOD 3MM

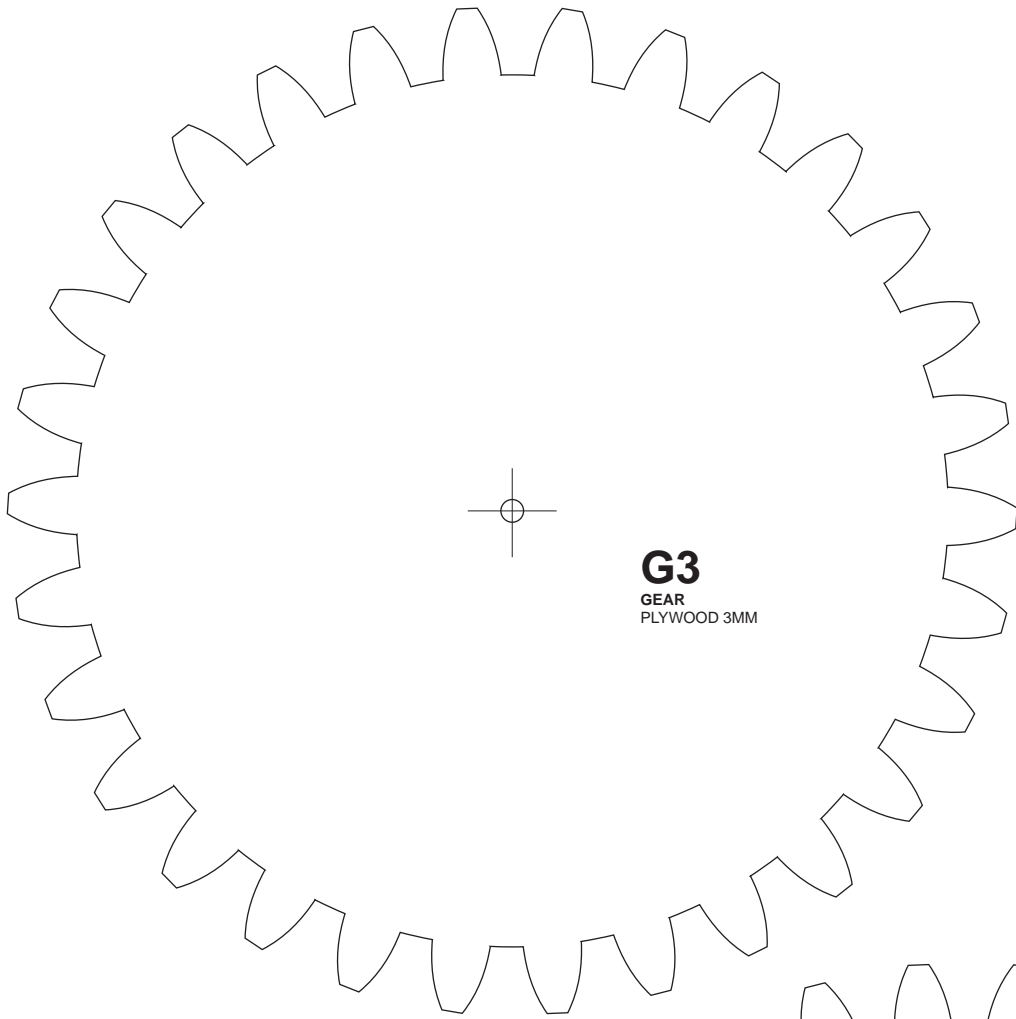

G3
GEAR
PLYWOOD 3MM

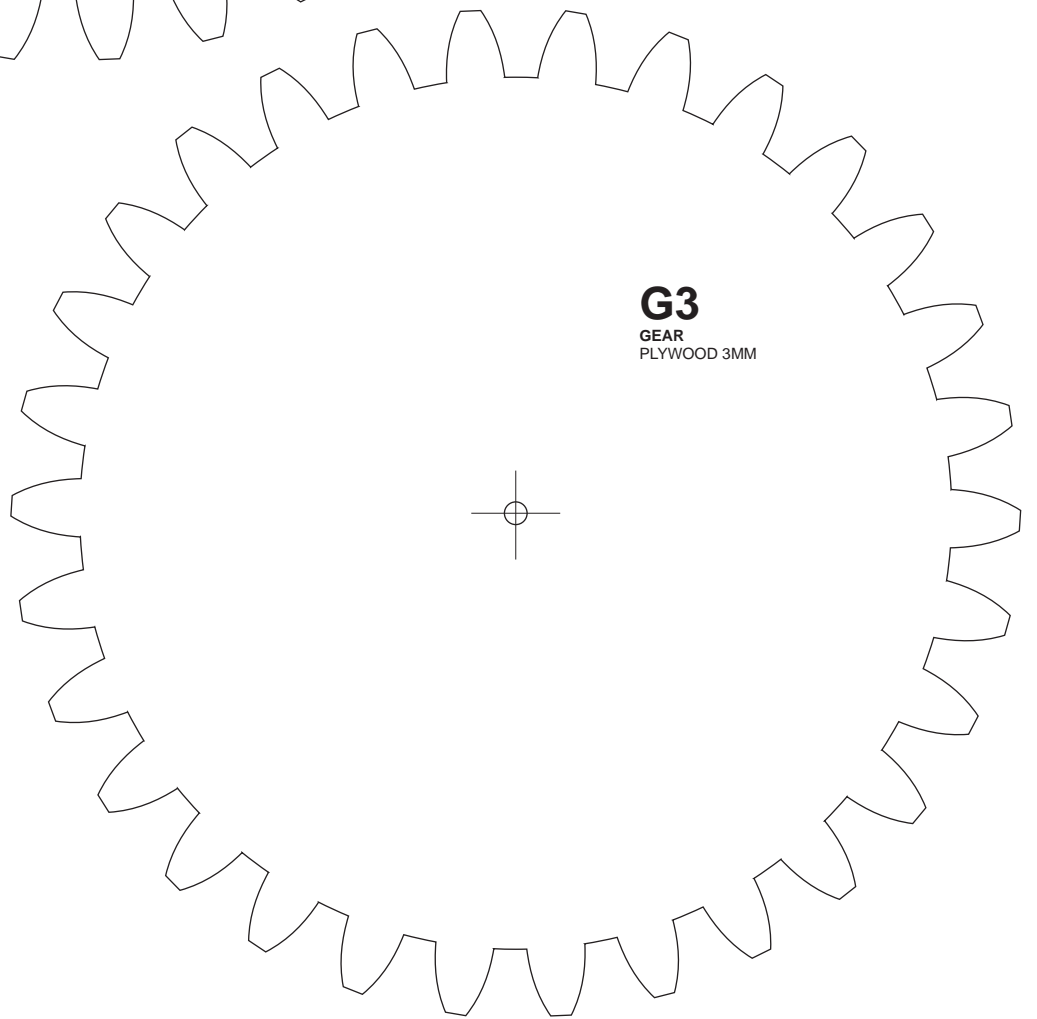

G3
GEAR
PLYWOOD 3MM

B1
CAR BODY
DEPRON/ POLYFOAM 3MM

B1A
B1 hole

JOIN HERE

JOIN HERE

JOIN HERE

B1

JOIN HERE

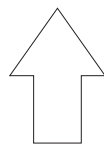

BACK

B2

CAR BODY
DEPRON/ POLYFOAM 3MM
2X MIRRORED

B3

CAR BODY FORMER
DEPRON/ POLYFOAM 5MM
2X

B5

CAR BODY
DEPRON/
POLYFOAM
3MM

B6

CAR BODY
DEPRON/
POLYFOAM
3MM

B4

CAR BODY
DEPRON/ POLYFOAM 3MM

JOIN HERE

JOIN HERE

JOIN HERE

JOIN HERE

JOIN HERE

JOIN HERE

B4

B5

B6

B7

CAR BODY
DEPRON/ POLYFOAM 3MM
2X MIRRORED

JOIN HERE



JOIN HERE

B7

B8

CAR BODY FORMER
DEPRON/ POLYFOAM 5MM
2X

B9

CAR BODY
DEPRON/ POLYFOAM 3MM
2X MIRRORED

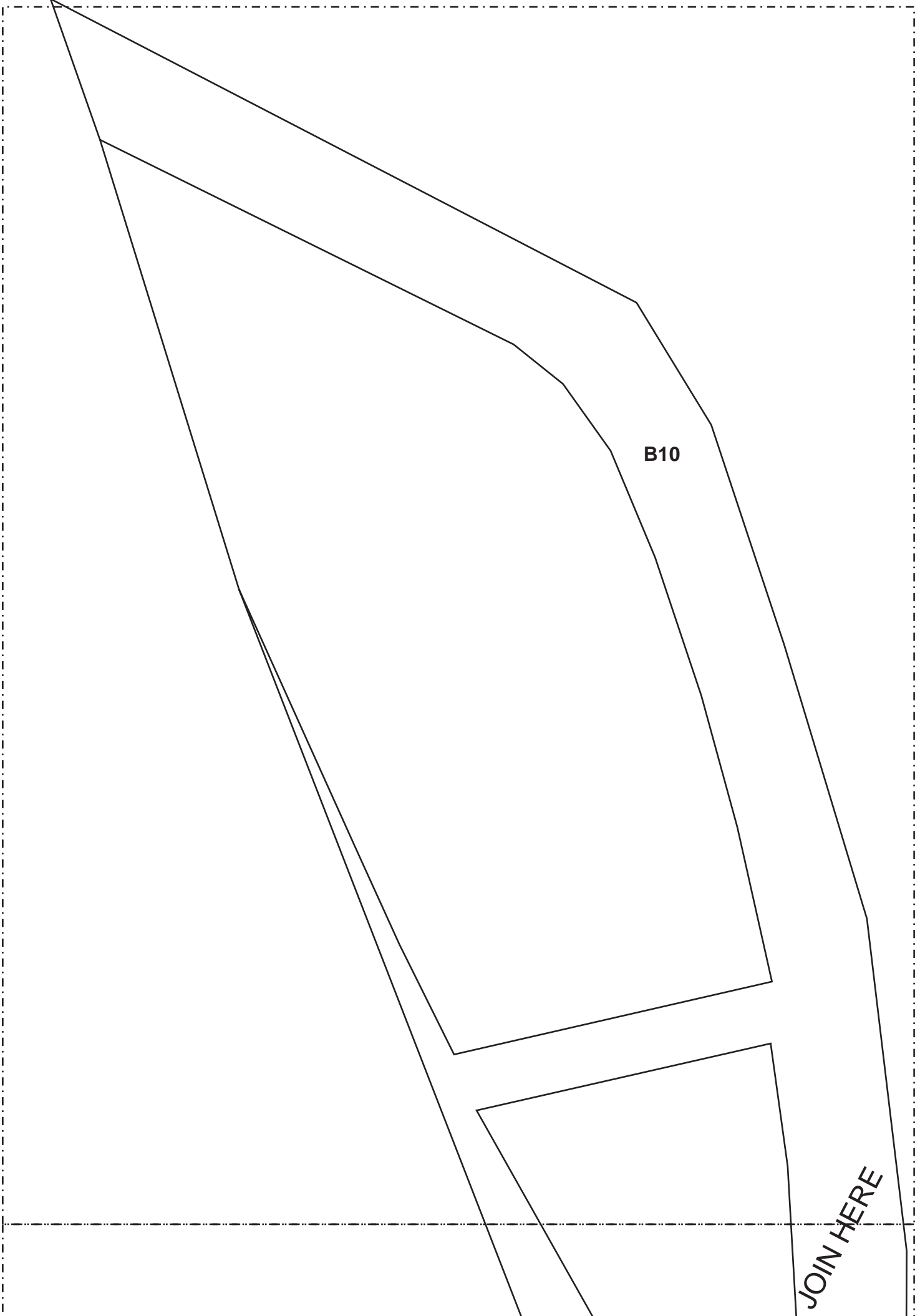

B10

JOIN HERE

JOIN HERE

B10

CAR BODY
DEPRON/ POLYFOAM 3MM
2X MIRRORED

B11

CAR BODY
DEPRON/ POLYFOAM 3MM

JOIN HERE

JOIN HERE

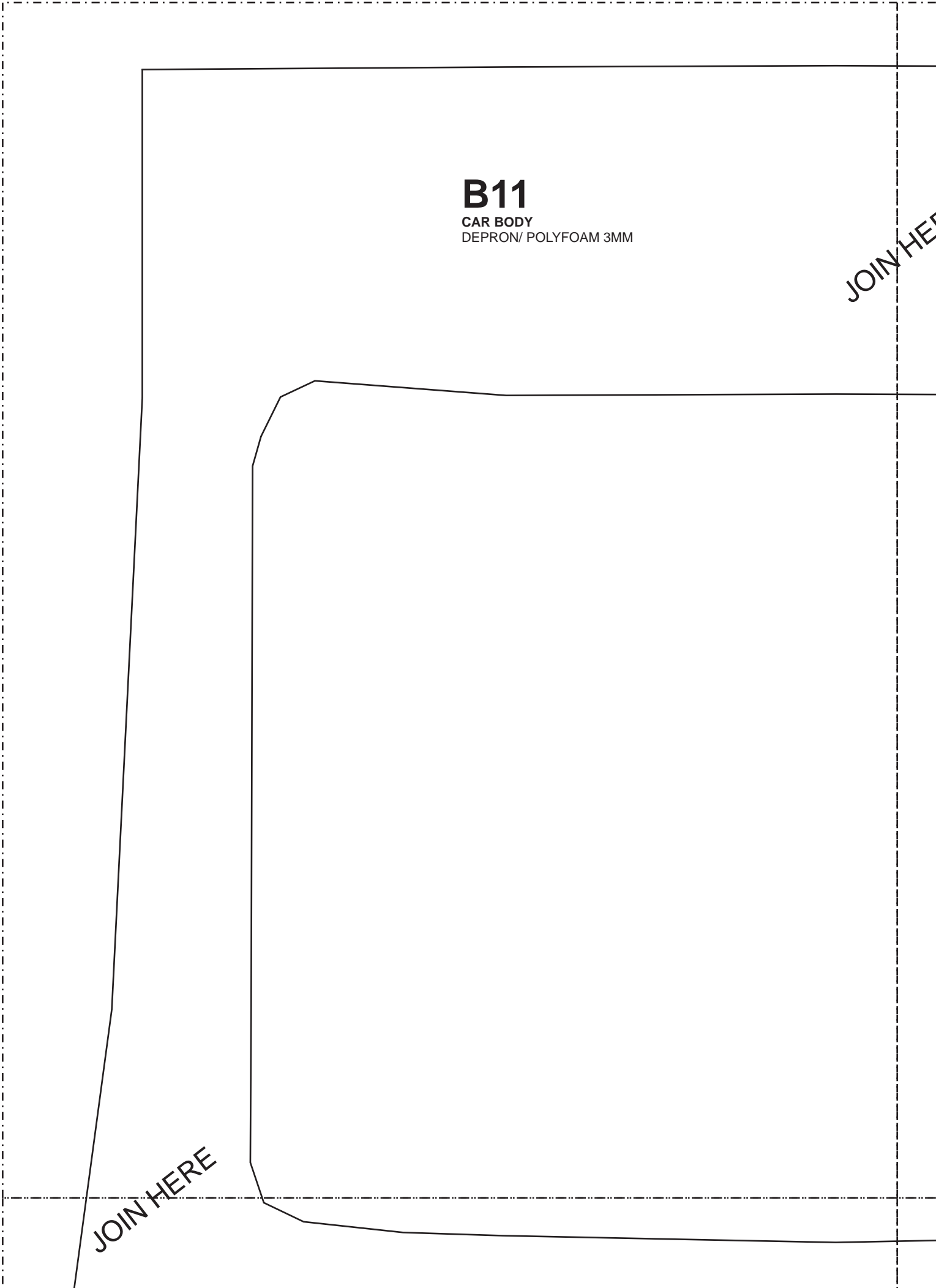

JOIN HERE

B11

JOIN HERE

JOIN HERE

B11

JOIN HERE

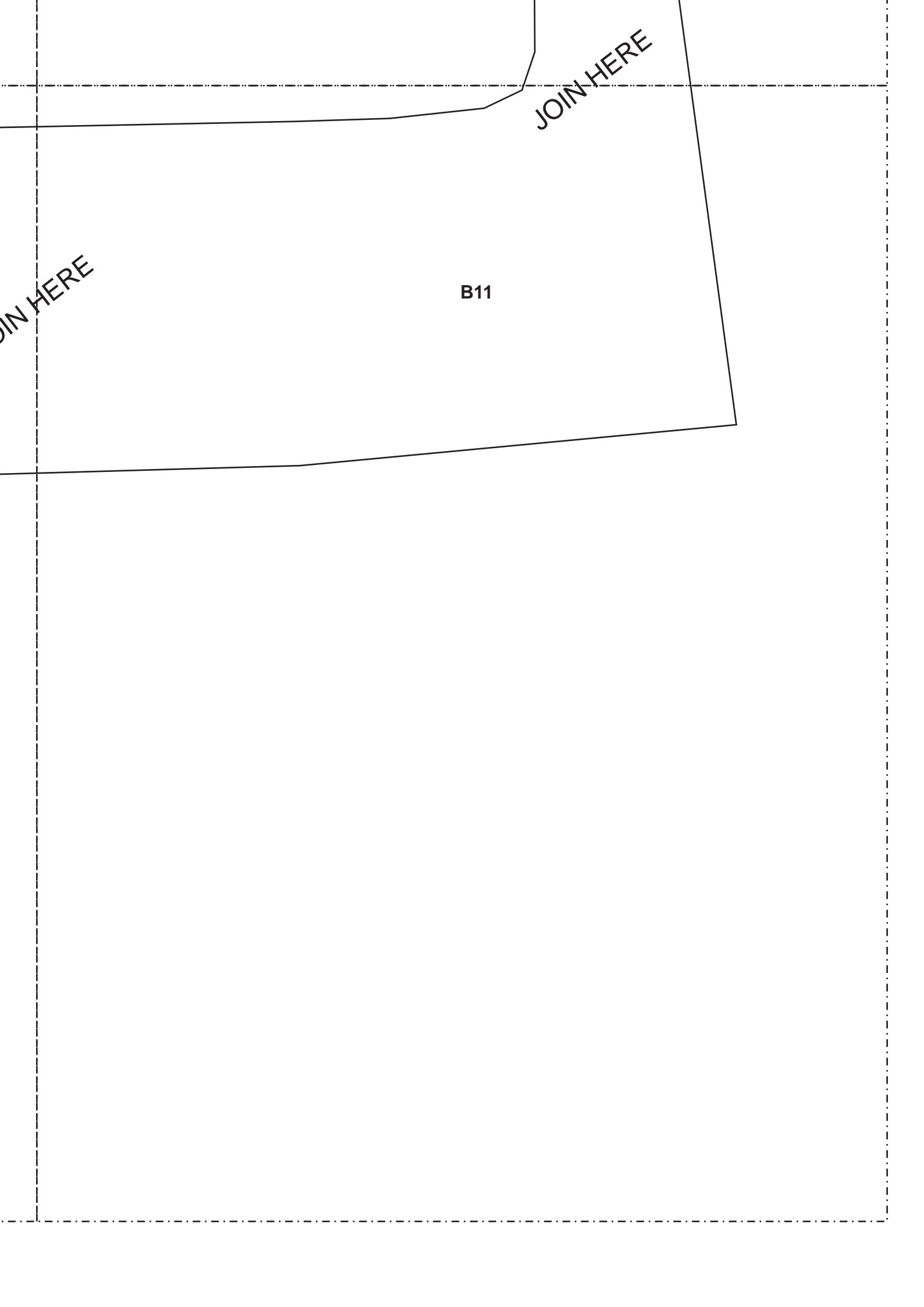

JOIN HERE

B11

JOIN HERE



B12

CAR BODY
DEPRON/ POLYFOAM 3MM

JOIN HERE

JOIN HERE

B12

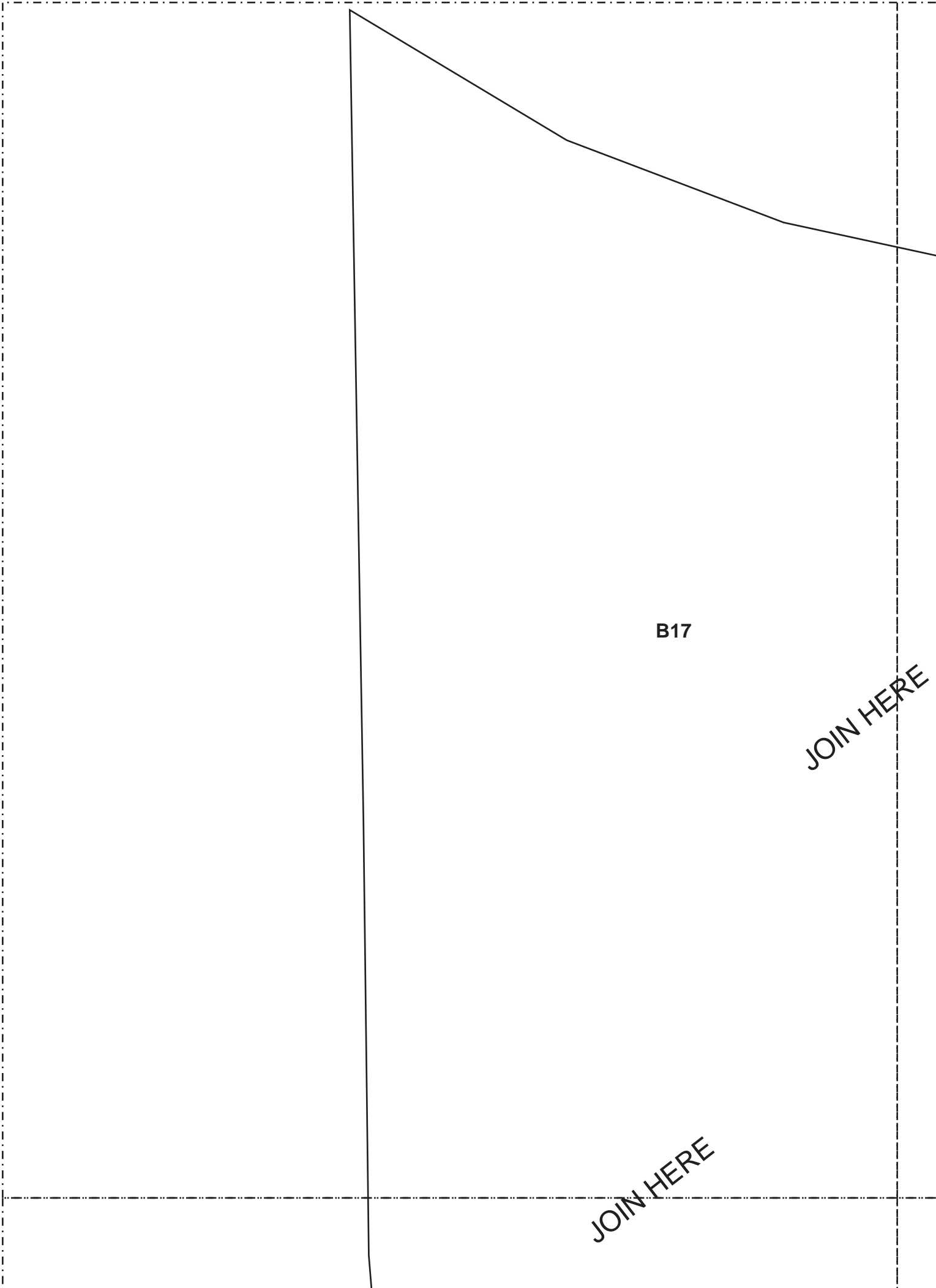

B17

JOIN HERE

JOIN HERE

HERE

B17

JOIN HERE

JOIN HERE

B17

JOIN HERE

JOIN HERE

B32

CAR BODY FORMER
DEPRON/ POLYFOAM 5MM
2X

JOIN HERE

JOIN HERE

B17

CAR BODY
DEPRON/ POLYFOAM 3MM

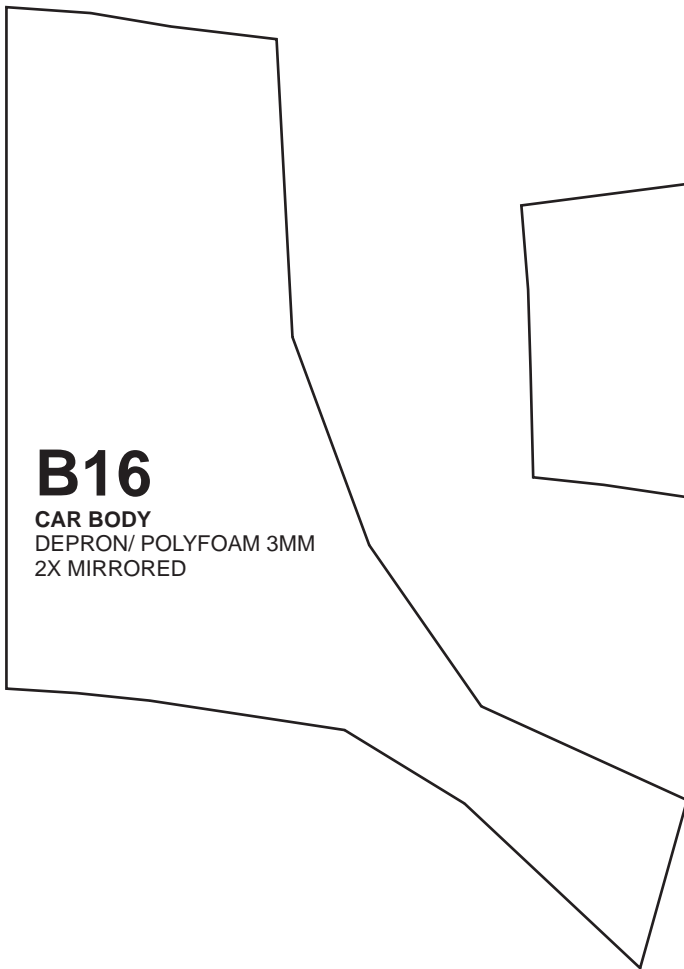

B16

CAR BODY
DEPRON/ POLYFOAM 3MM
2X MIRRORED

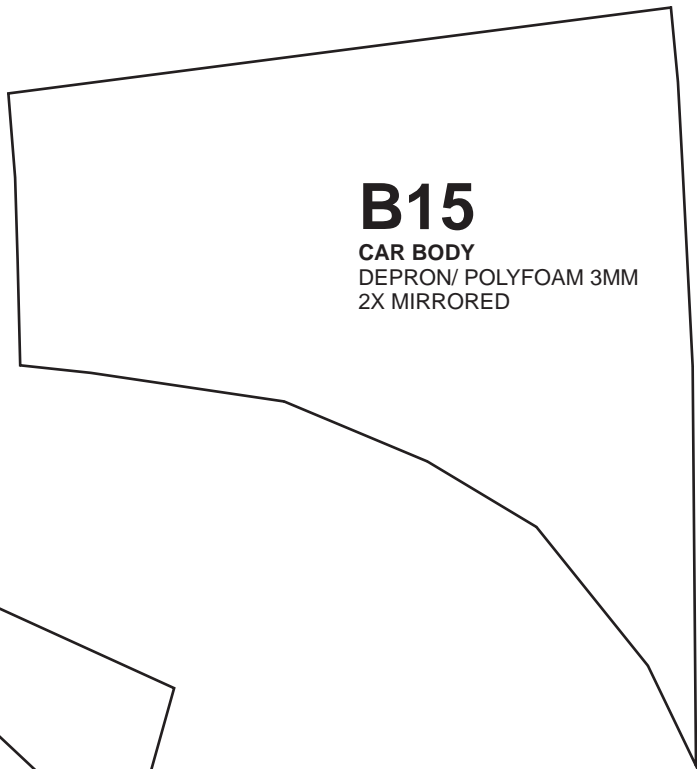

B15

CAR BODY
DEPRON/ POLYFOAM 3MM
2X MIRRORED

JOIN HERE

B17

B13

CAR BODY
DEPRON/ POLYFOAM 3MM
2X MIRRORED

JOIN HERE

B17

JOIN HERE

B32

B14

CAR BODY FORMER
DEPRON/ POLYFOAM 5MM
2X

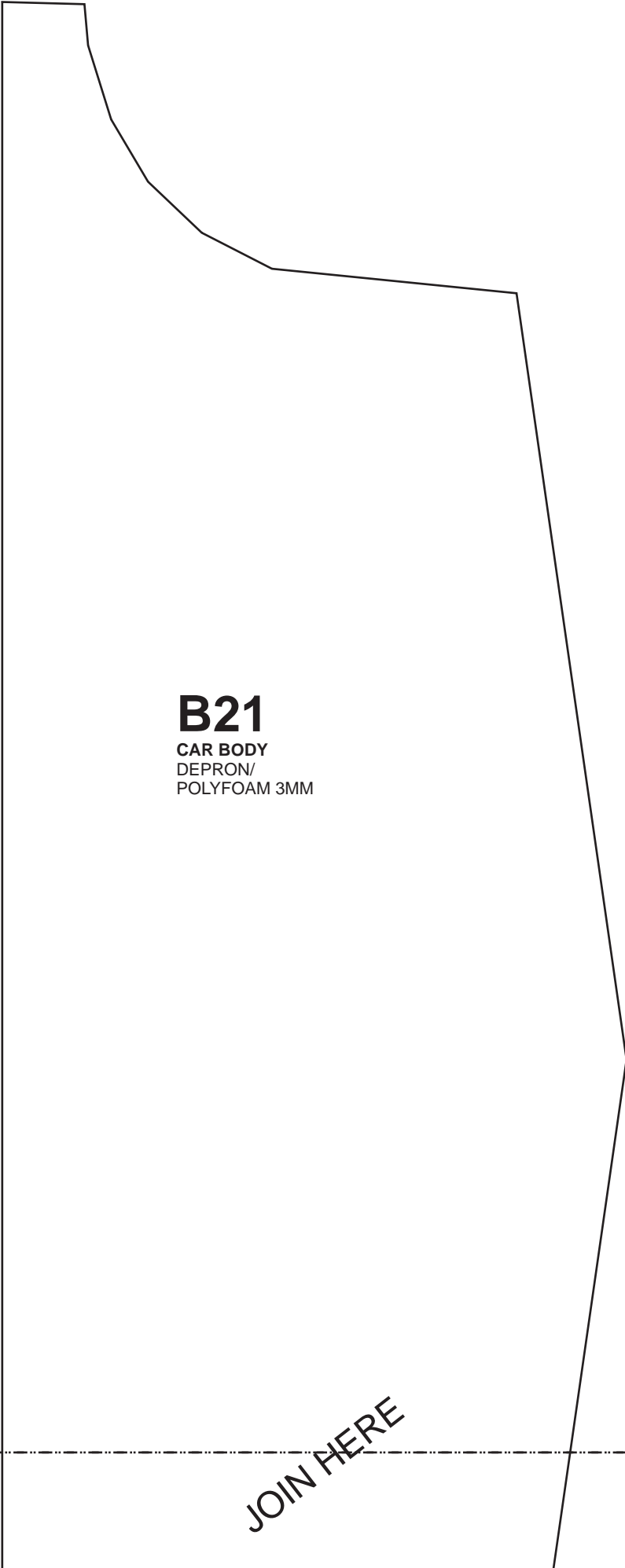

B21
CAR BODY
DEPRON/
POLYFOAM 3MM

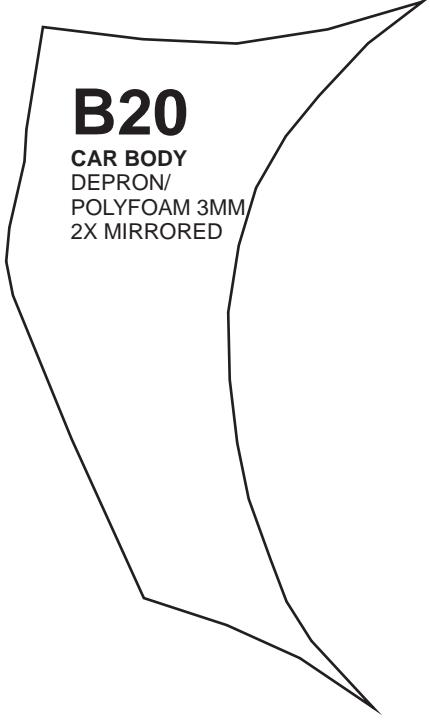

B20
CAR BODY
DEPRON/
POLYFOAM 3MM
2X MIRRORED

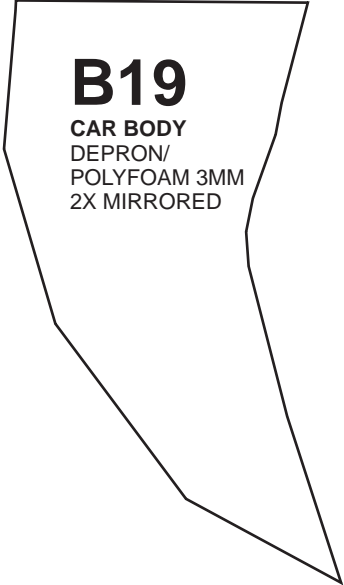

B19
CAR BODY
DEPRON/
POLYFOAM 3MM
2X MIRRORED

JOIN HERE

JOIN HERE

B21

B18

CAR BODY
DEPRON/
POLYFOAM 3MM
2X MIRRORED

B24
CAR BODY
DEPRON/ POLYFOAM 3MM

B23
CAR BODY
DEPRON/ POLYFOAM 3MM

JOIN HERE

JOIN HERE

B24



B22

CAR BODY
DEPRON/ POLYFOAM 5MM

JOIN HERE

JOIN HERE

B22

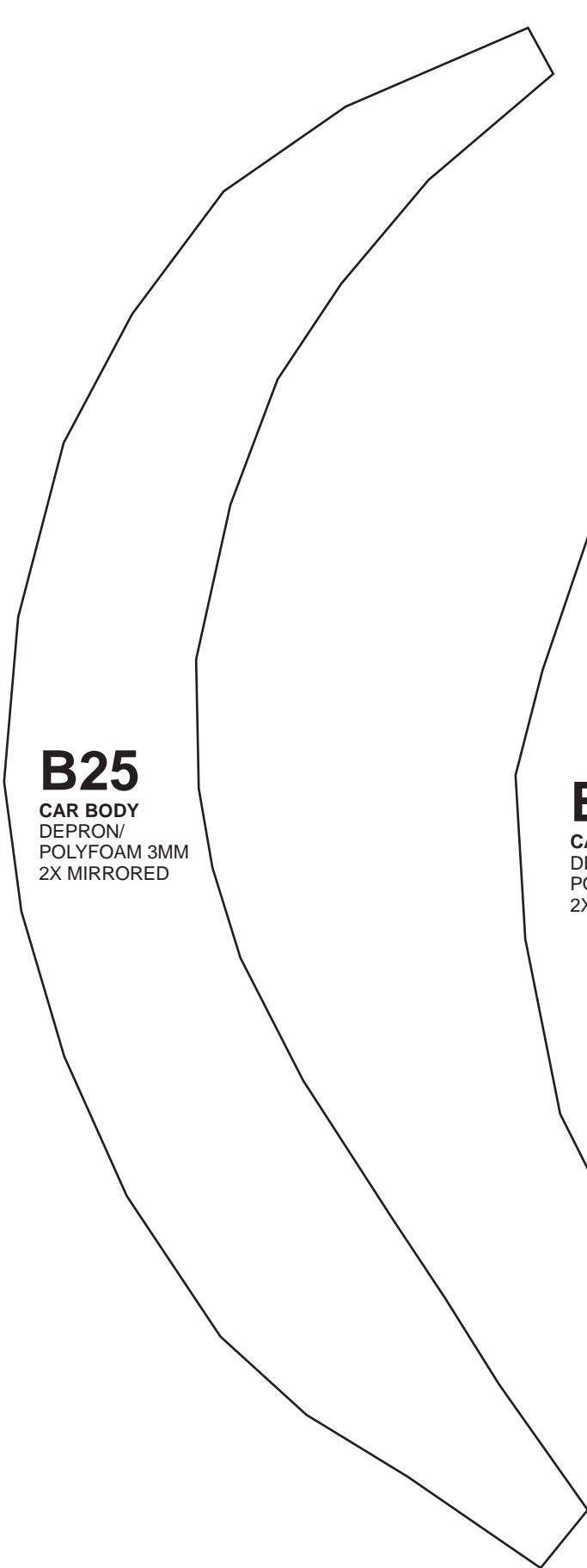

B25

CAR BODY
DEPRON/
POLYFOAM 3MM
2X MIRRORED

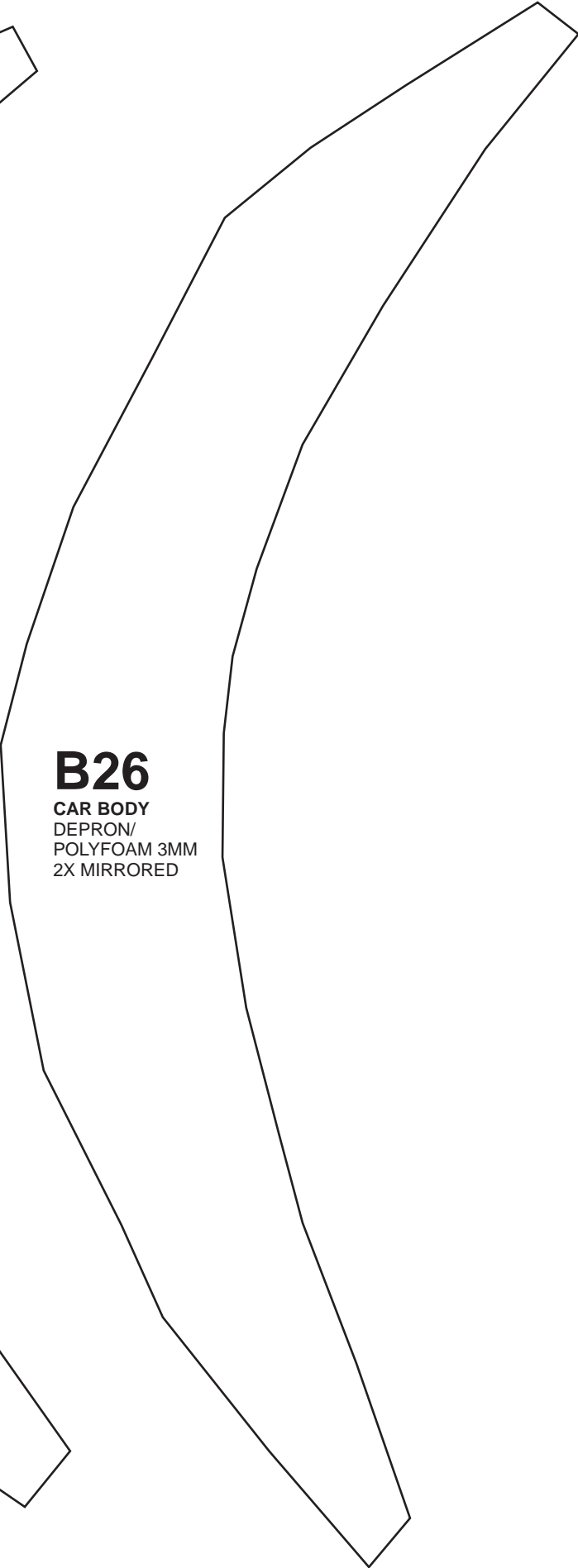

B26

CAR BODY
DEPRON/
POLYFOAM 3MM
2X MIRRORED



B27

CAR BODY
MICA PLASTIC 0.5MM

JOIN HERE

JOIN HERE

B27

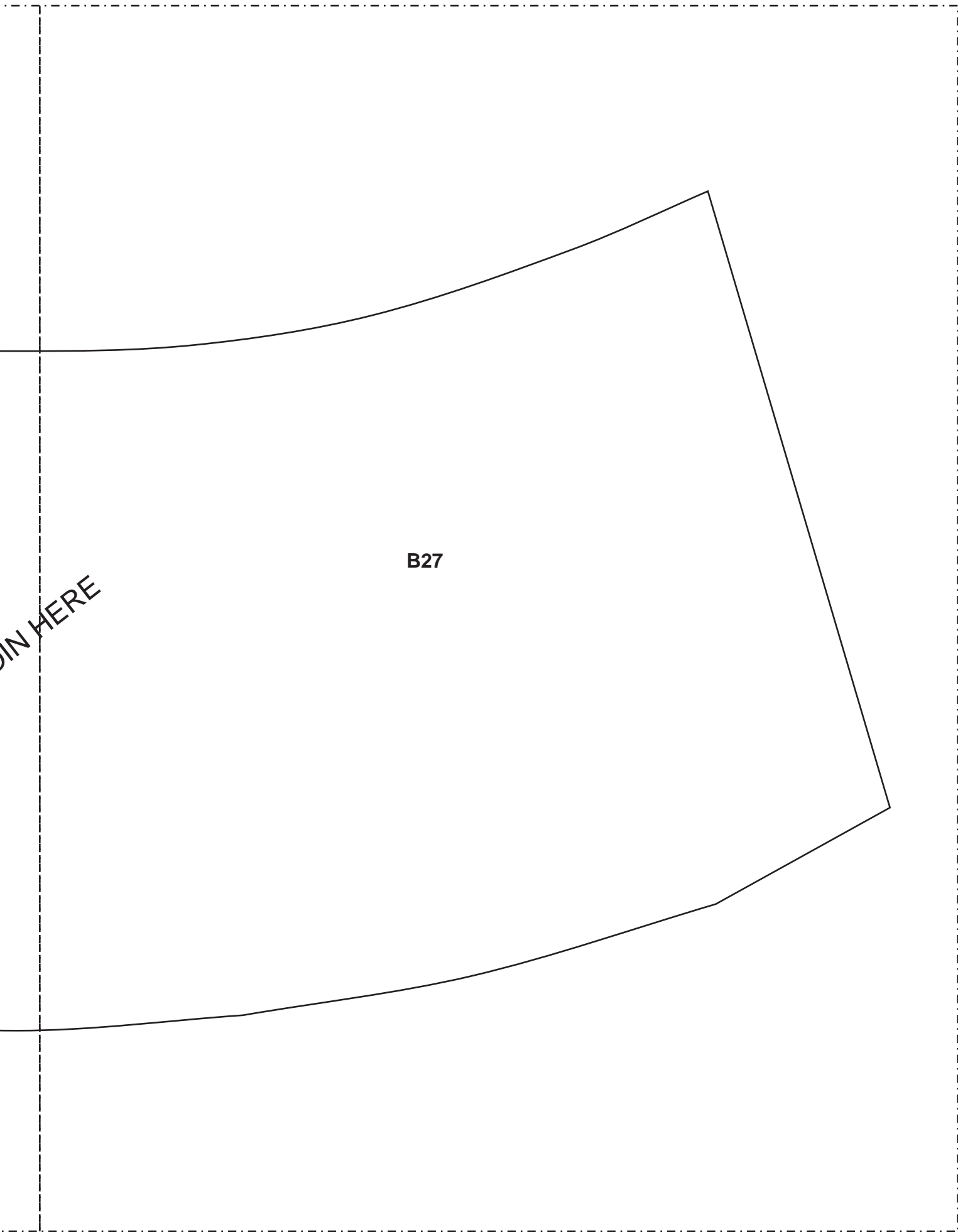

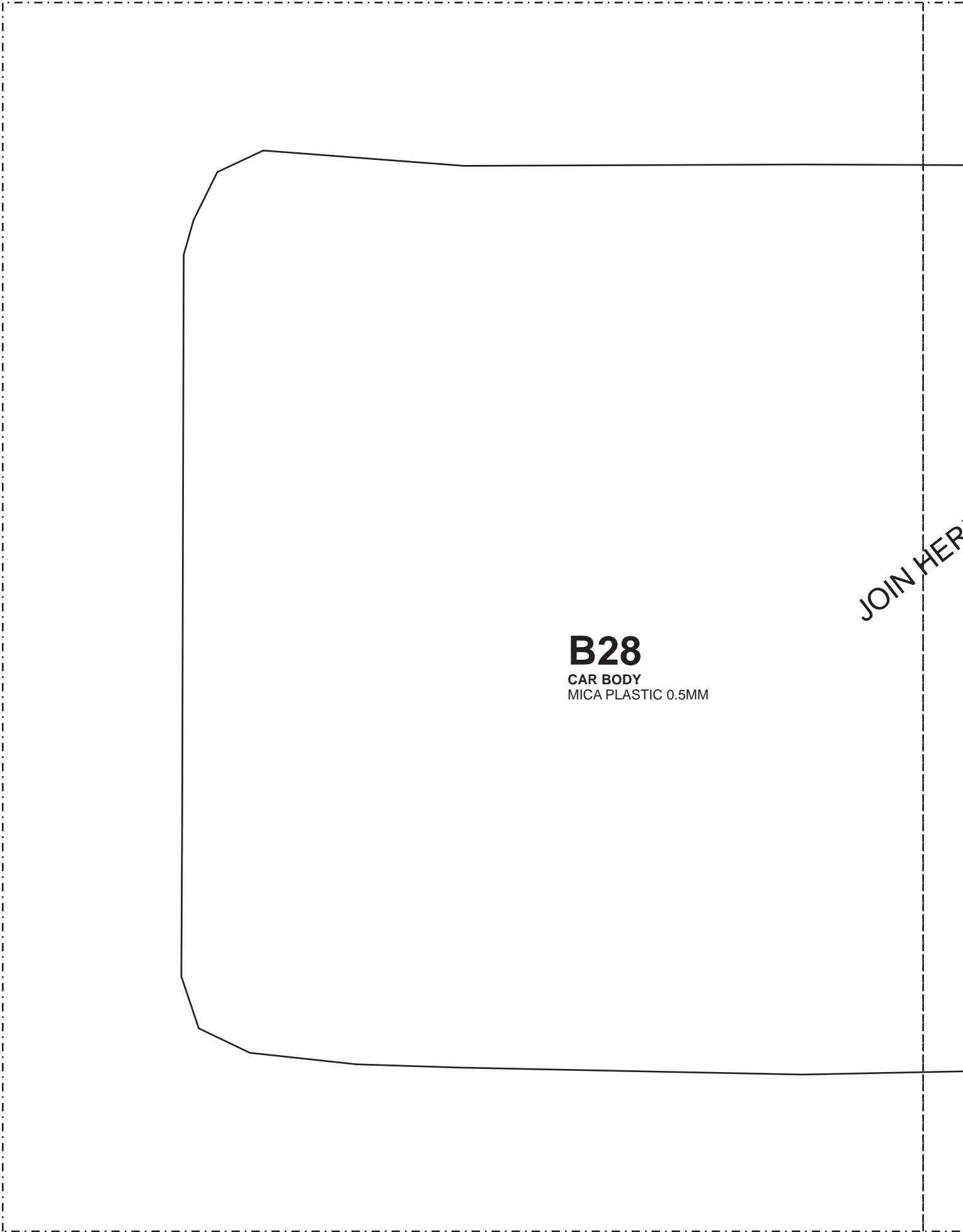

JOIN HERE

B28

CAR BODY
MICA PLASTIC 0.5MM

JOIN HERE

B28

B29

CAR BODY
MICA PLASTIC 0.5MM
2X

B31

CAR BODY
DEPRON/
POLYFOAM 3MM

B30

CAR BODY
DEPRON/
POLYFOAM 3MM

JOIN HERE

JOIN HERE

JOIN HERE

JOIN HERE

B31

B30

FRONT
TURN SIGNAL
LAMP

MICA PLASTIC

MICA PLASTIC

MICA PLASTIC

MICA PLASTIC

MICA PLASTIC

MICA PLASTIC

MICA PLASTIC

MICA PLASTIC

MICA PLASTIC

MICA PLASTIC

L2

L2

L2

L2



B33
CAR BODY
EVA FOAM 10MM

JOIN HERE

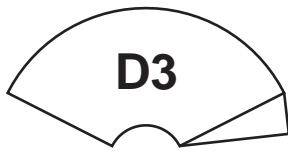
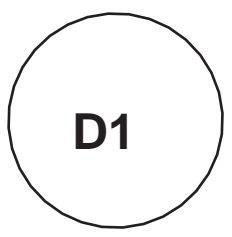
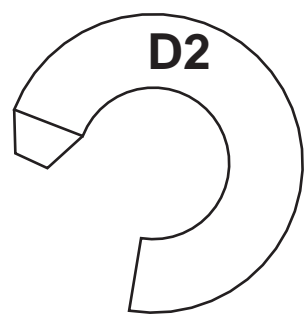
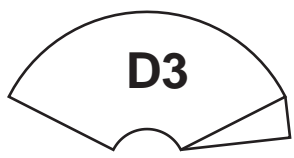
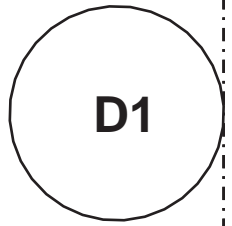
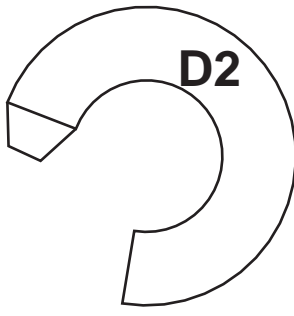

JOIN HERE

B33

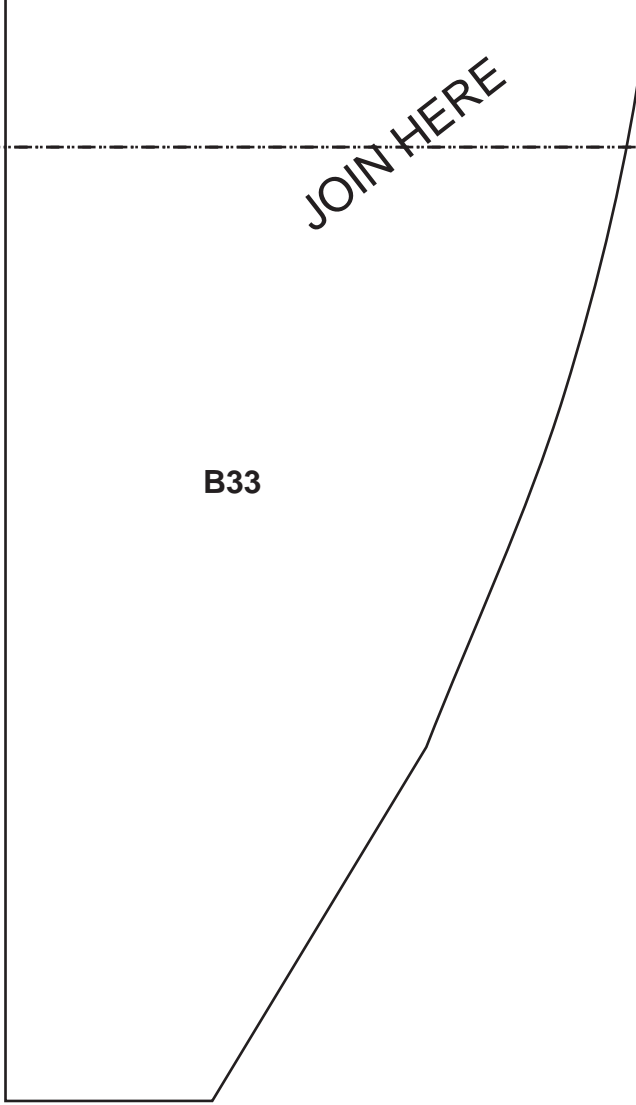

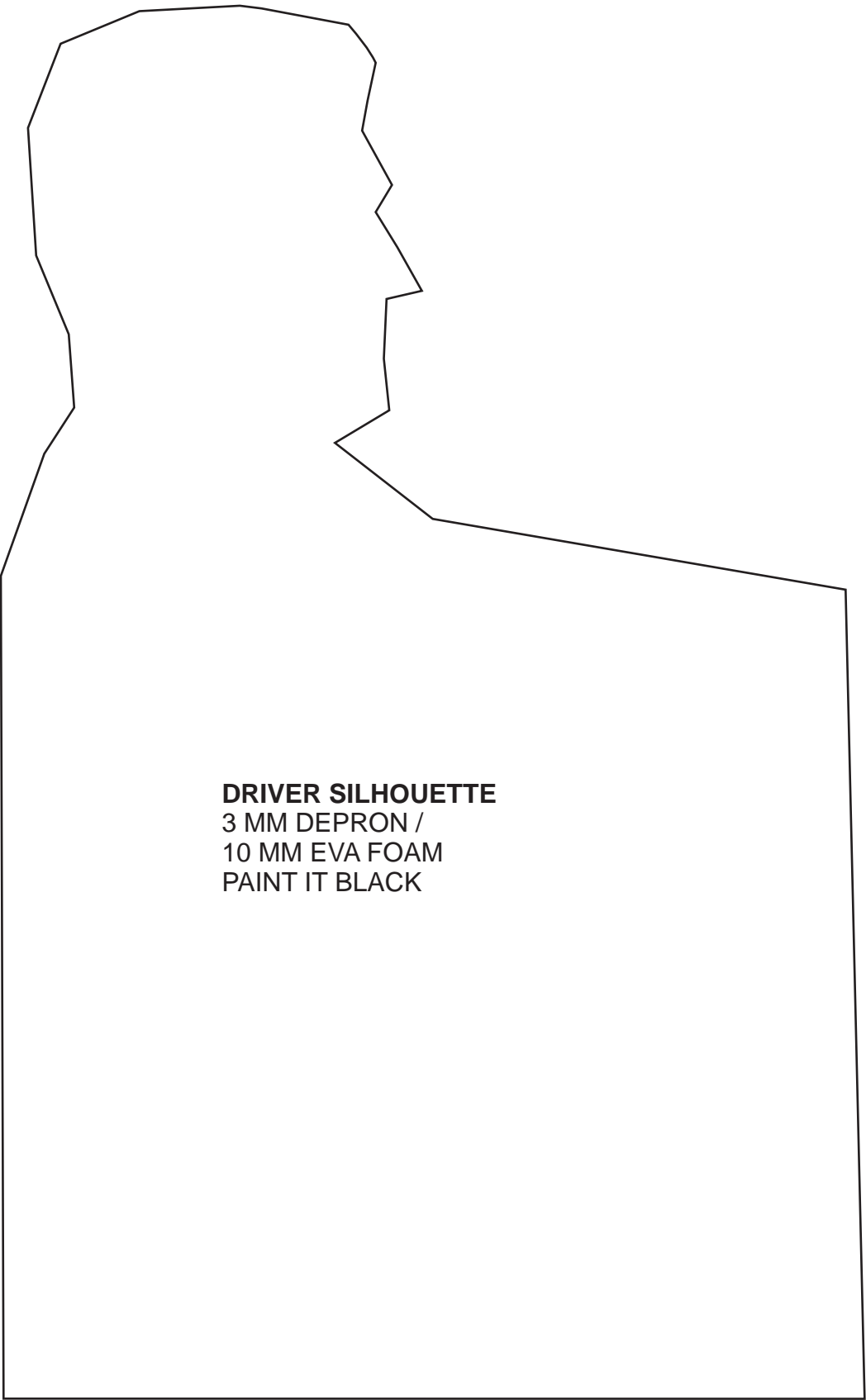

DRIVER SILHOUETTE
3 MM DEPRON /
10 MM EVA FOAM
PAINT IT BLACK