



Model : 15/2020



T-2 Buckeye

1300mm

Specs :

1. Wingspan 1300
2. Flying weight : 1400 grams/ 49.4 oz
3. Wing loading : 42.4 g/dm² - 13.9 oz/sq.ft
4. Wing cube loading : 7.4
5. Wing Area : 33 dm² / 512 sq.in
6. CG : 7.5 cm from LE (see wing plans)

Electronics

- NTM 28-30 1000kv 370 watt
- Propeller : 8x6x4
- ESC 50A
- Battery Lipo 4S 2200mah
- 4 plastic gear 9 gram servos
- 3 metal gear servo
- mechanical retract / servoless retract

Materials :

1. 3 mm Depron/ Polyfoam
2. 5 mm Depron/ Polyfoam
3. 7 mm + 3 mm Plywood
4. Hot glue, CA glue, PVA glue, Epoxy Glue
5. 3 mm bicycle wheel spoke wire
6. 1.5 mm wire
7. white packing tape / wax paper
8. chopsticks, toothpick
9. 10 mm EVA foam (black)
10. 0.3 mm Mica plastic
11. Plastic tray

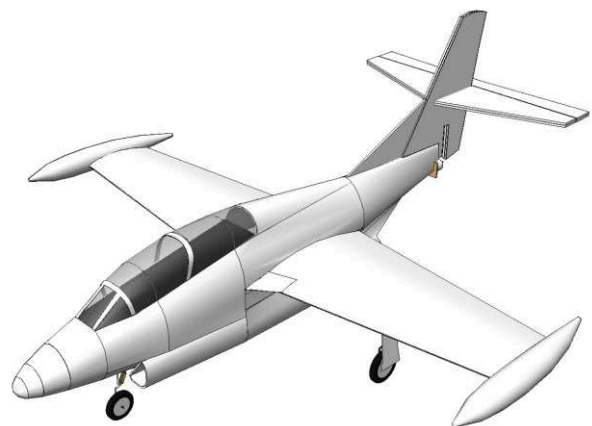

Build Instructions :

1. paper-replika.com
2. youtube channel : Julius Perdana

FRONT LANDING GEAR

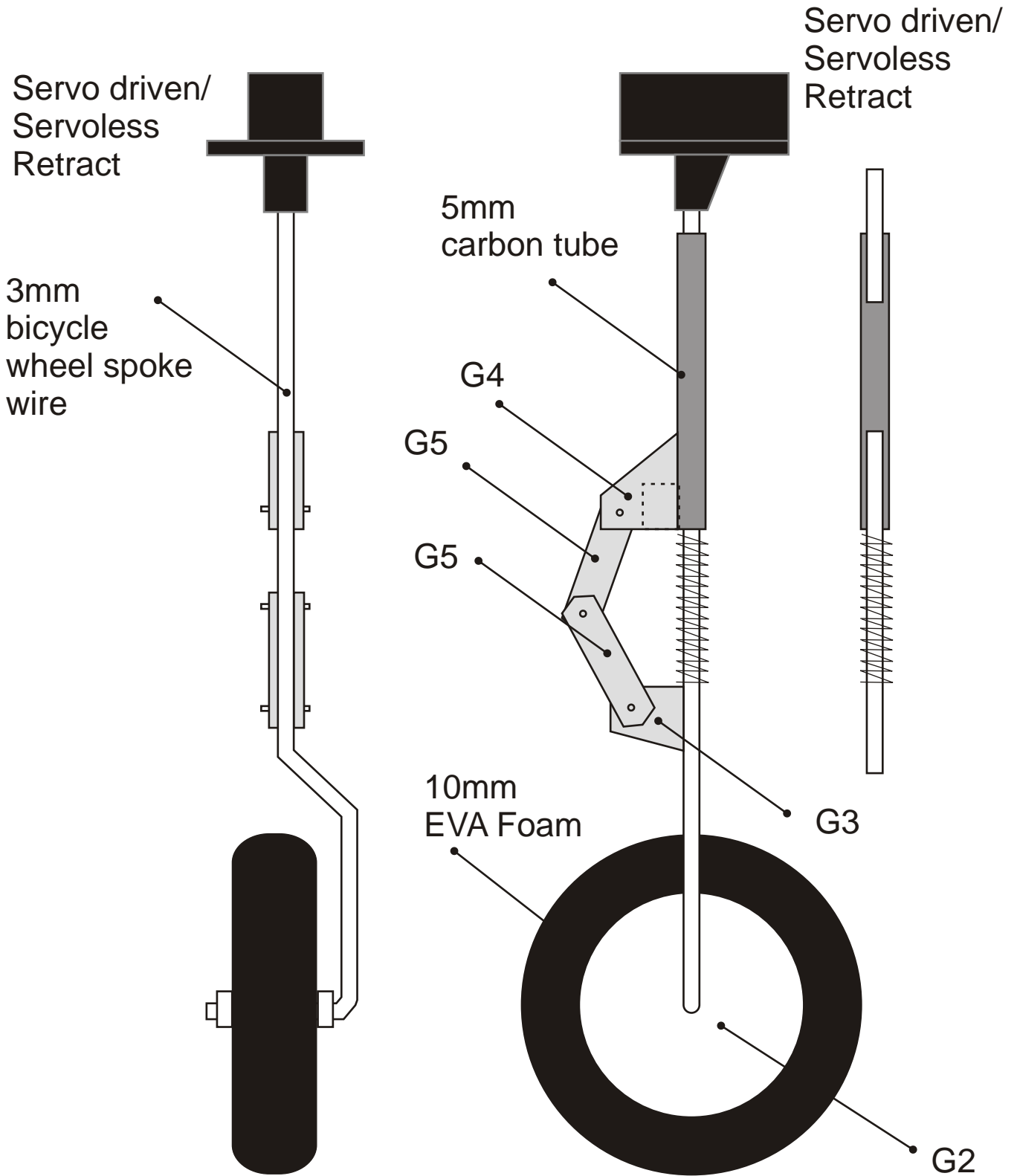

MAIN LANDING GEAR

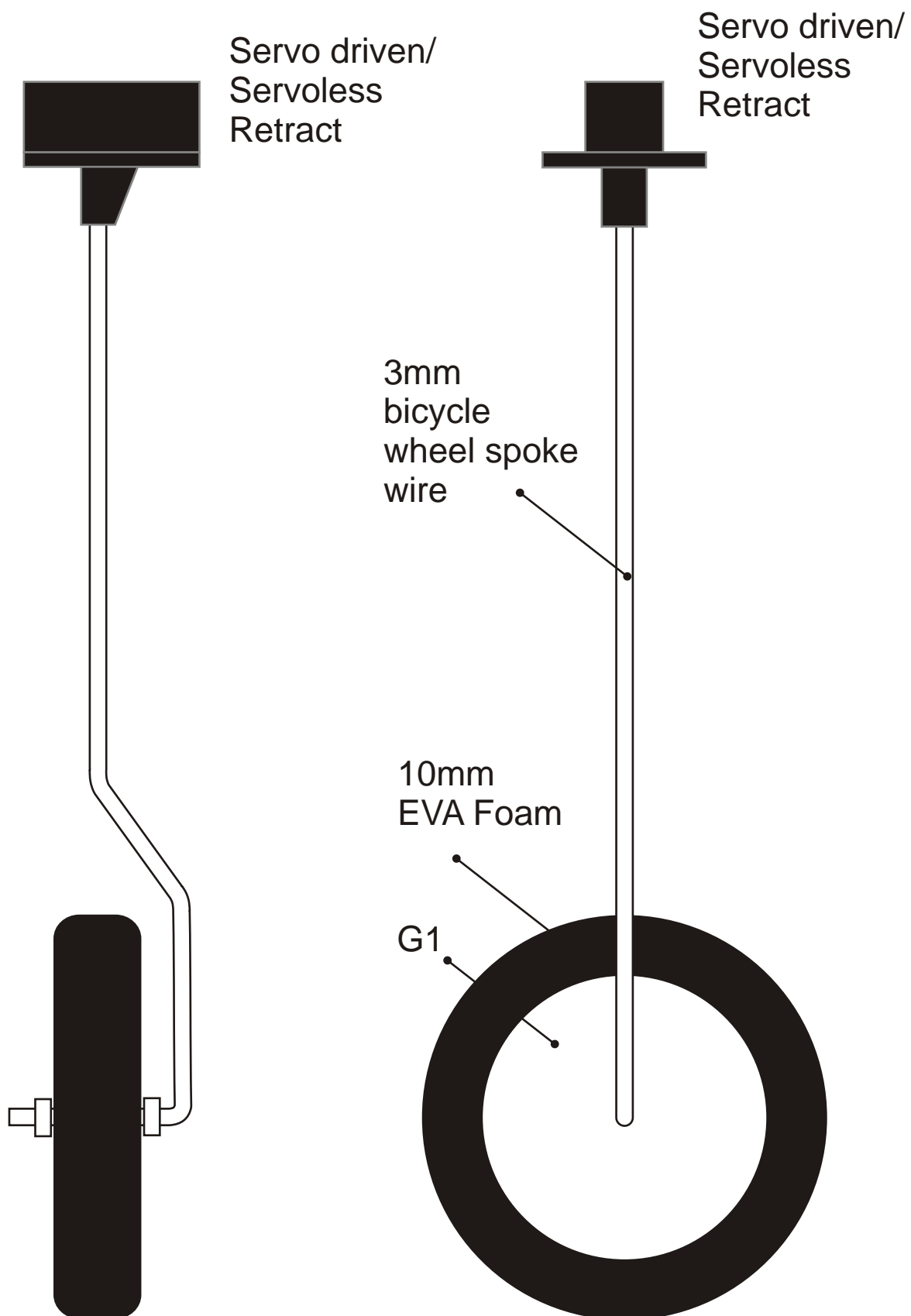

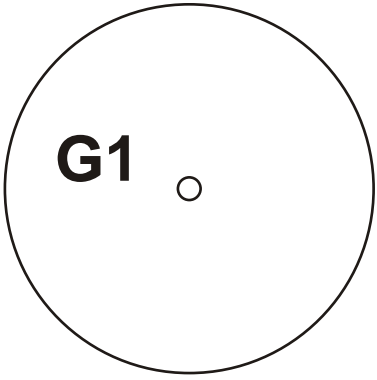

G1

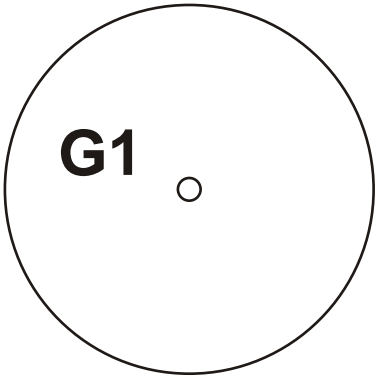

G1



G2

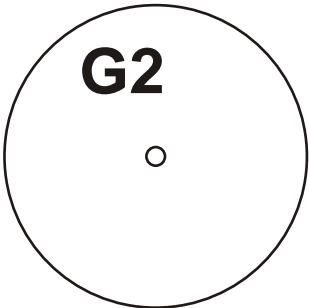

G2



W1

WING
POLYFOAM/ DEPRON 3 MM
2X MIRRORED

JOIN HERE

JOIN HERE

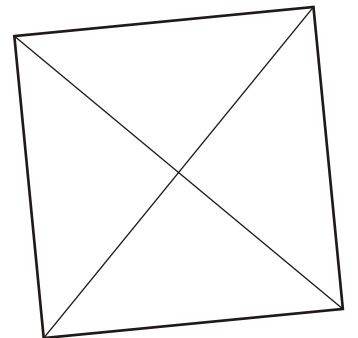

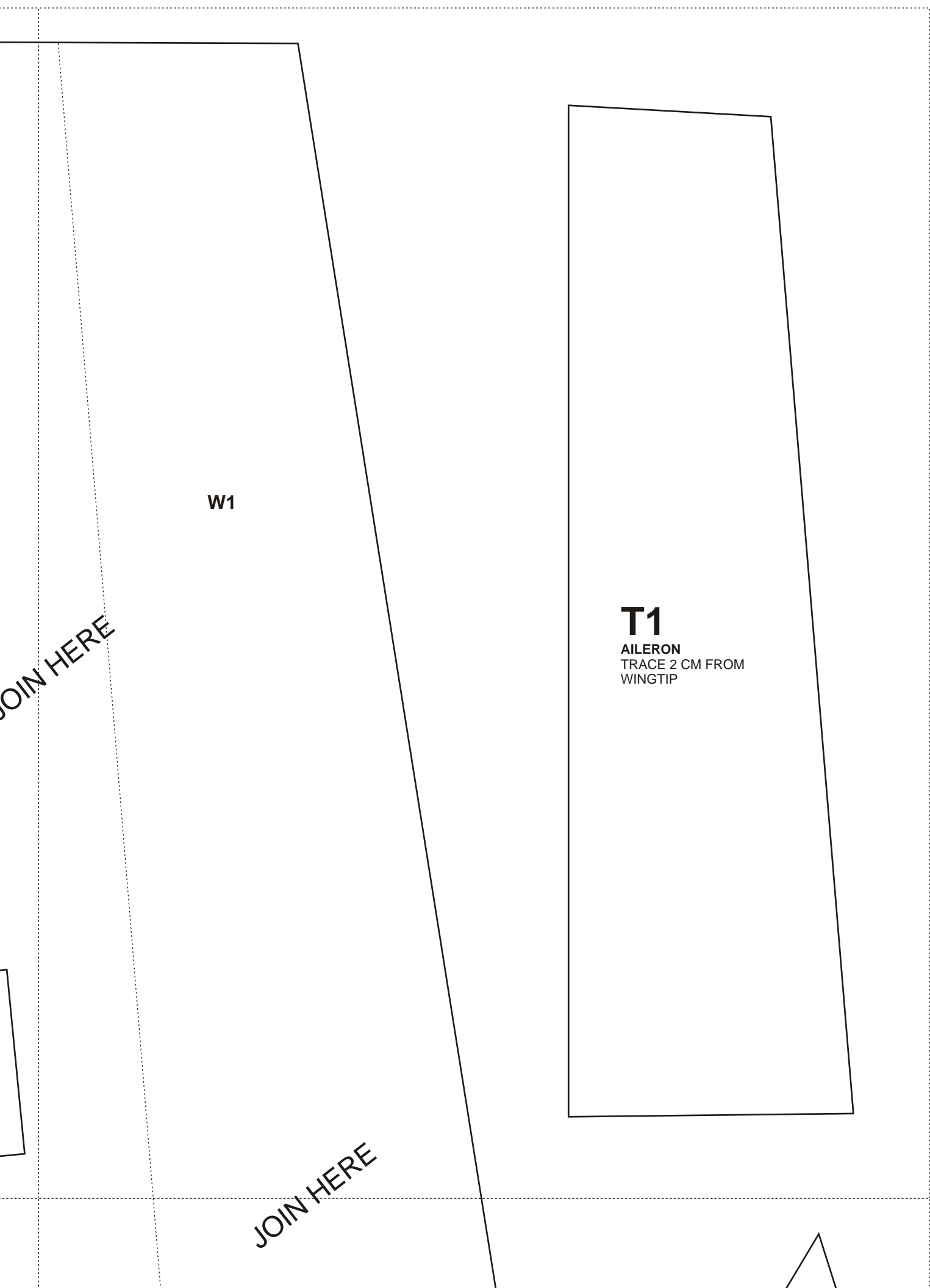

W1

JOIN HERE

JOIN HERE

T1

AILERON
TRACE 2 CM FROM
WINGTIP

JOIN HERE

W1

JOIN HERE

JOIN HERE

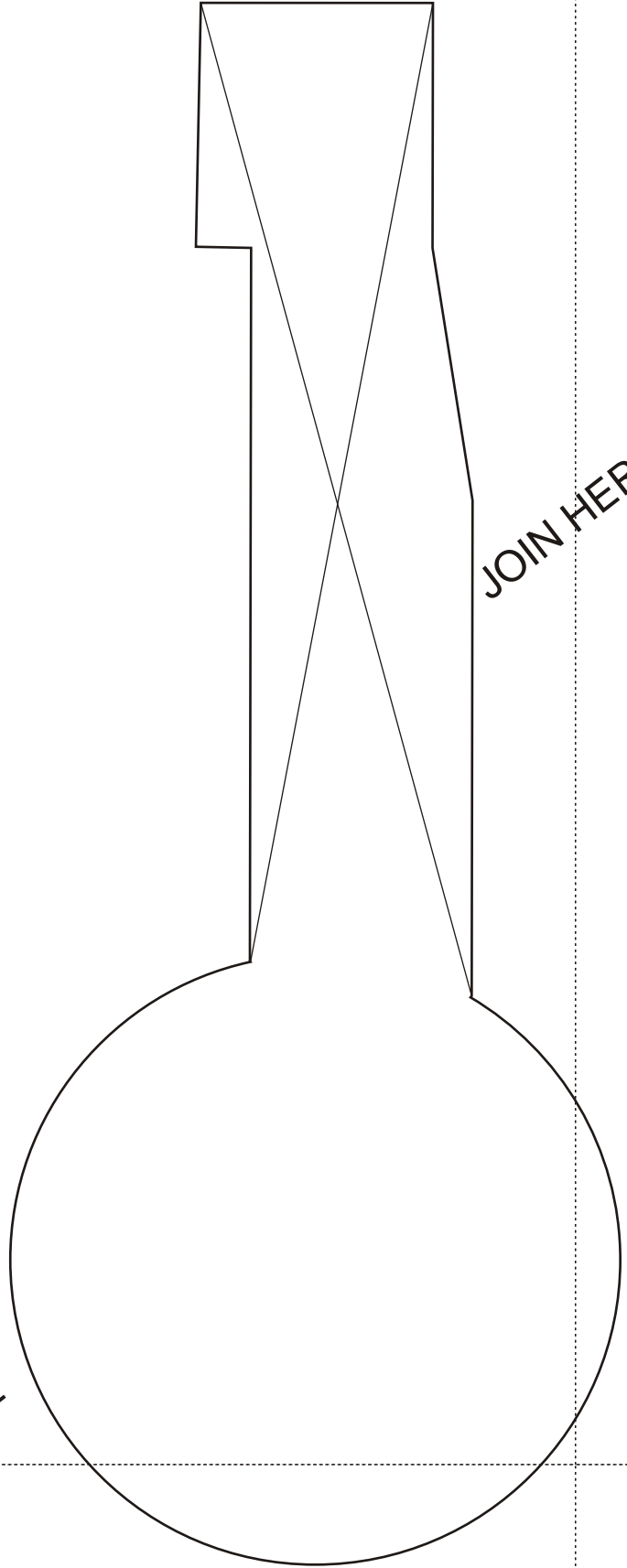

JOIN HERE

W1

W2

AIRFOIL FORMER
POLYFOAM/ DEPRON 5 MM
2X

JOIN HERE

JOIN HERE

JOIN HERE

JOIN HERE

JOIN HERE

W1

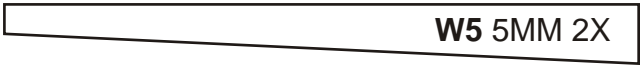
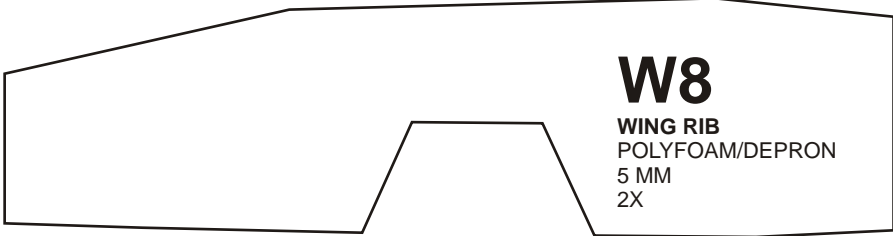
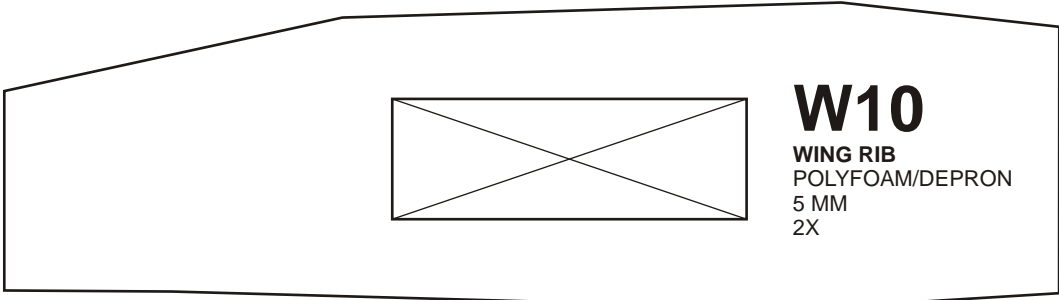

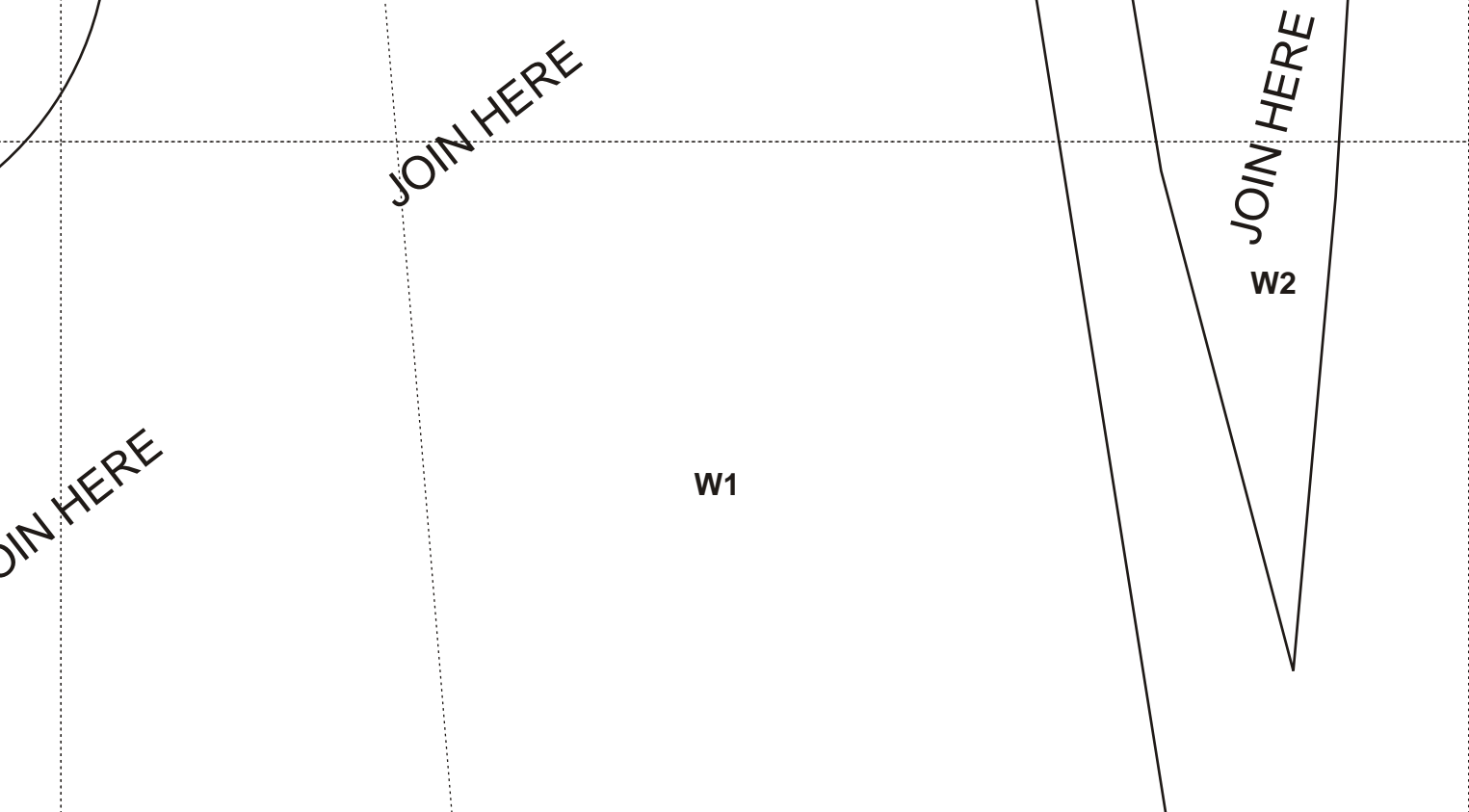

JOIN HERE

JOIN HERE

W2

W1

JOIN HERE

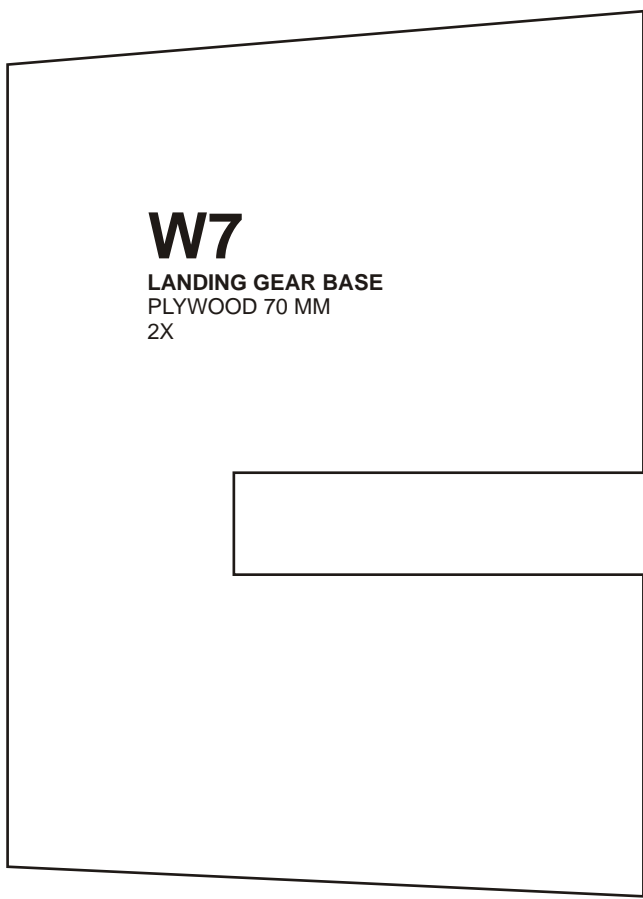

W7

LANDING GEAR BASE
PLYWOOD 70 MM
2X

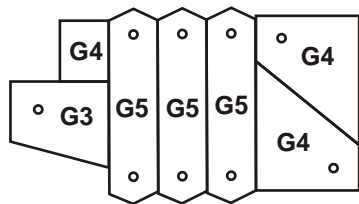

G4

G4

G3

G5

G5

G5

G4

W11

WING
POLYFOAM/ DEPRON 3 MM
2X MIRRORED

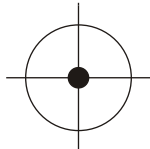

CG

JOIN HERE

JOIN HERE

JOIN HERE

JOIN HERE

W11

JOIN HERE

W3

JOIN HERE

W4

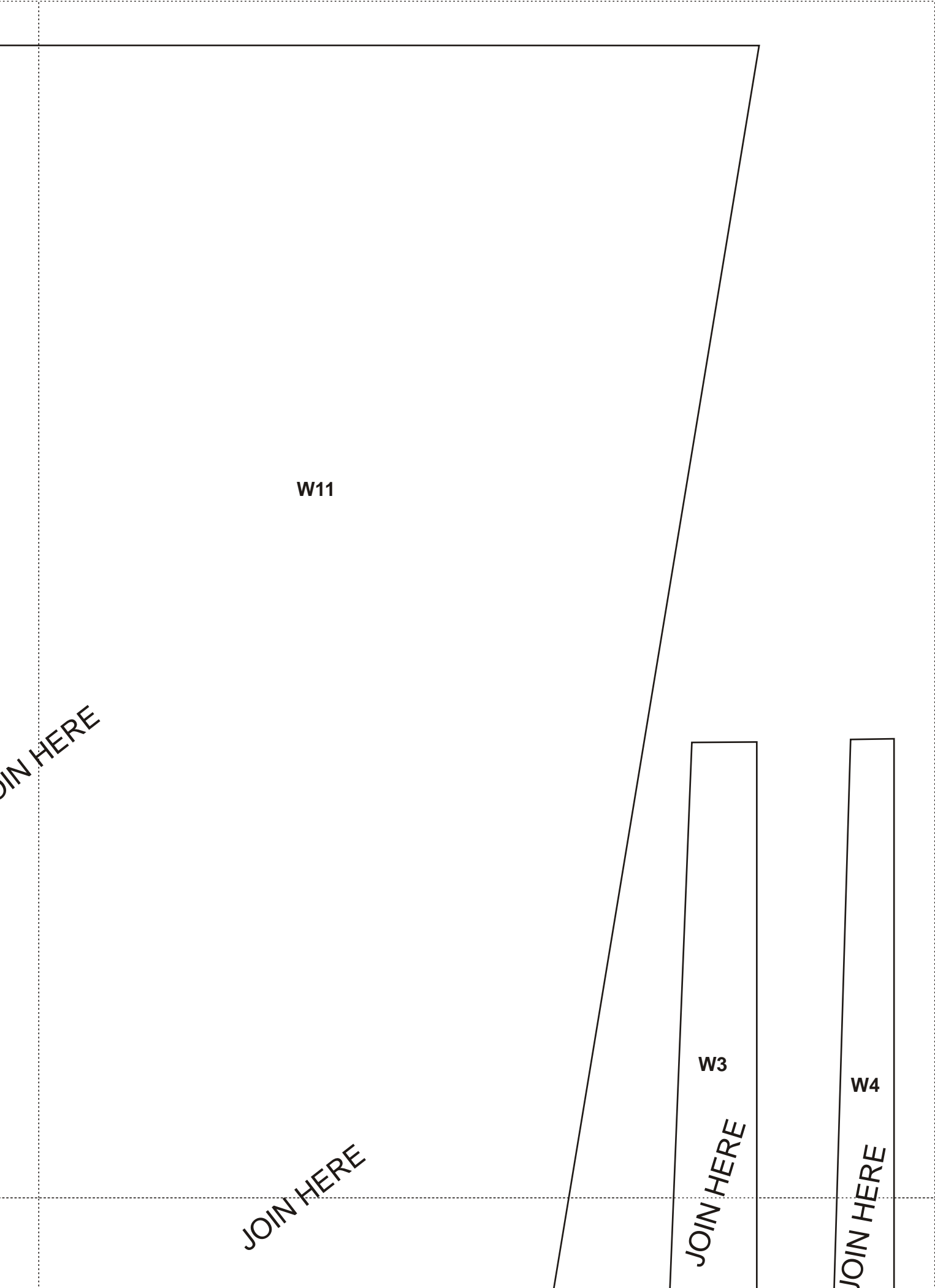

JOIN HERE

W11

JOIN HERE

JOIN HERE

JOIN HERE

W11

JOIN HERE

JOIN HERE

JOIN HERE

W3

JOIN HERE

JOIN HERE

W4

JOIN HERE

JOIN HERE

W11

C1

CANOPY
MICA PLASTIC 0.3 MM

C2

CANOPY
MICA PLASTIC 0.3 MM

JOIN HERE

W11

JOIN HERE

JOIN HERE

W3

WING SPAR 1
POLYFOAM/
DEPRON 5 MM
2X

W4

WING SPAR 2
POLYFOAM/
DEPRON 5 MM
2X

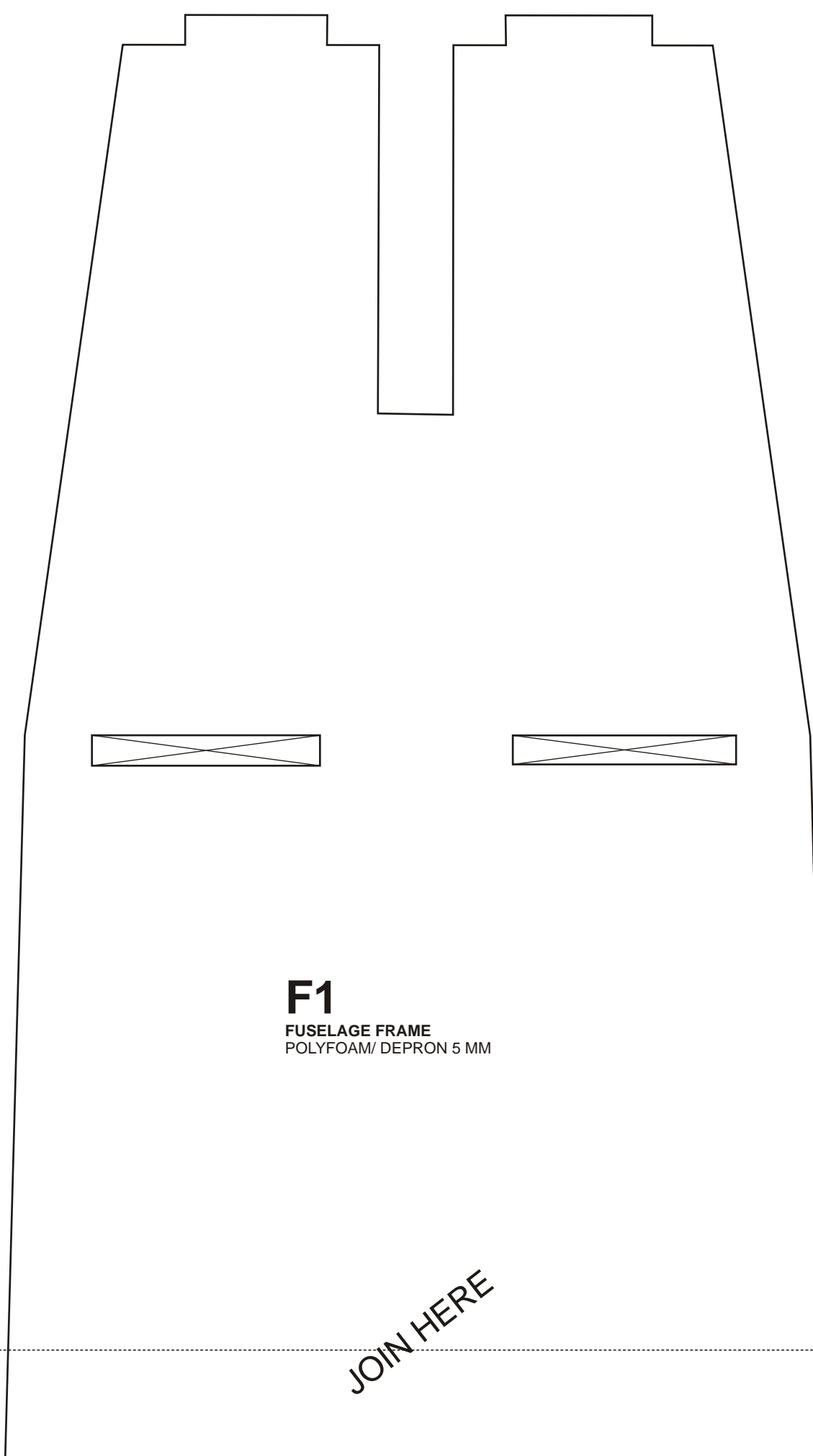

F1

FUSELAGE FRAME
POLYFOAM/ DEPRON 5 MM

JOIN HERE

JOIN HERE

F1

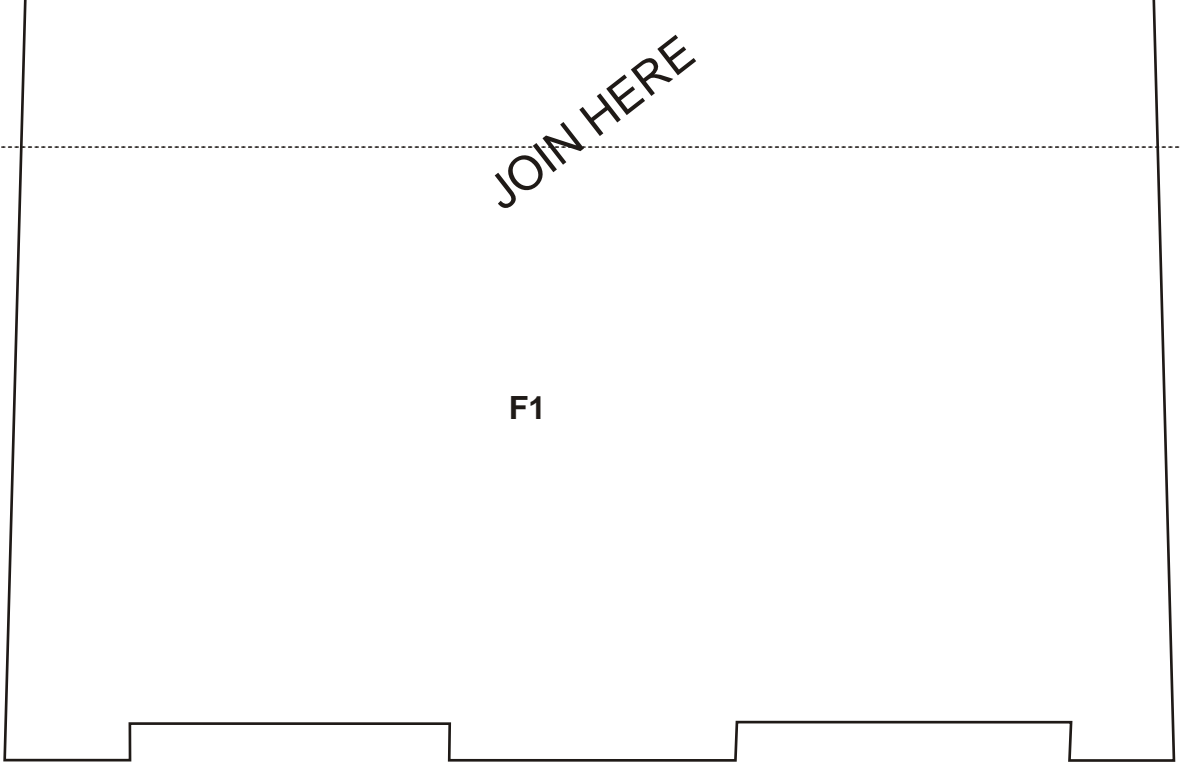

F4

FUSELAGE FORMER
POLYFOAM/ DEPRON 5 MM

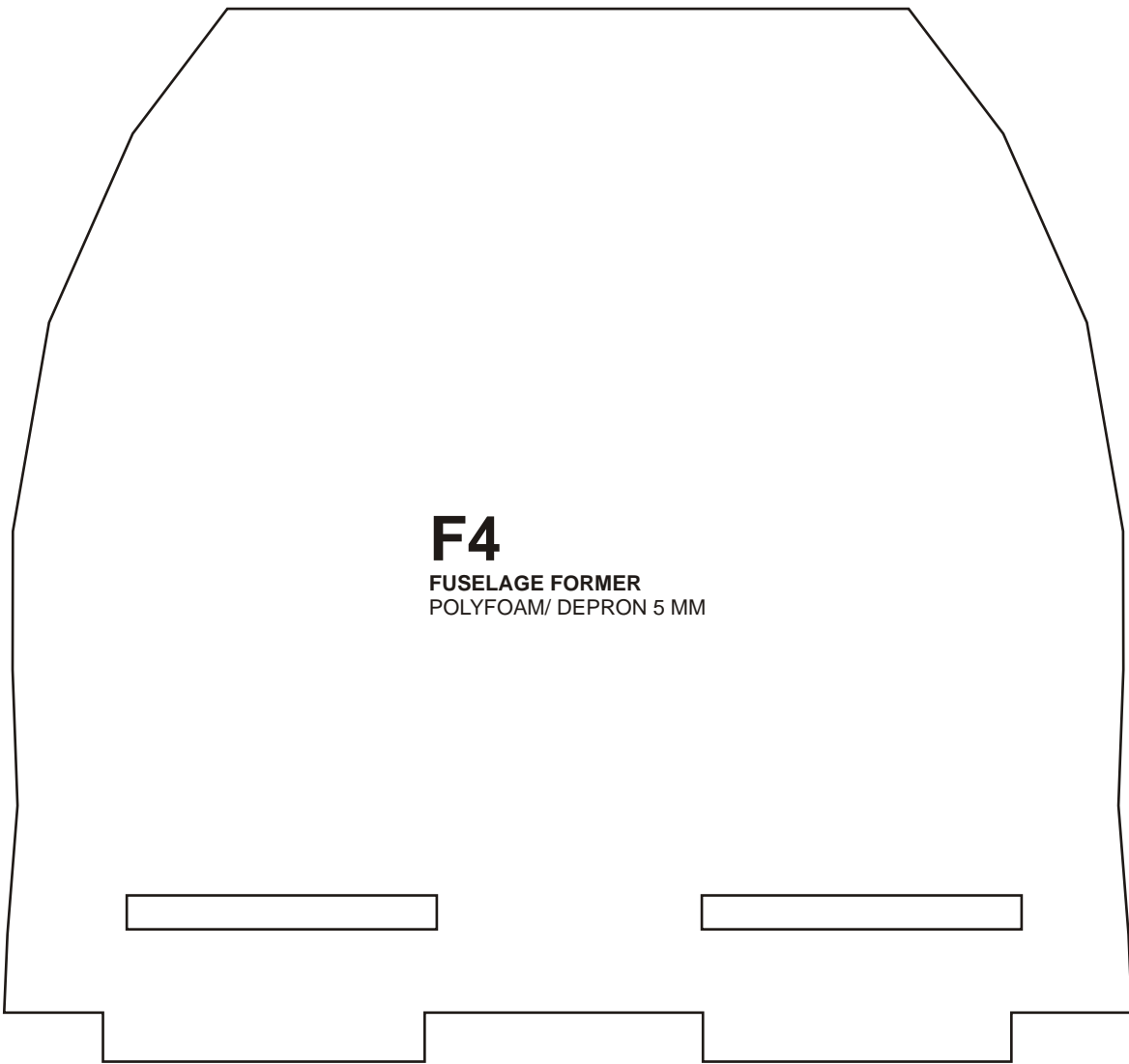

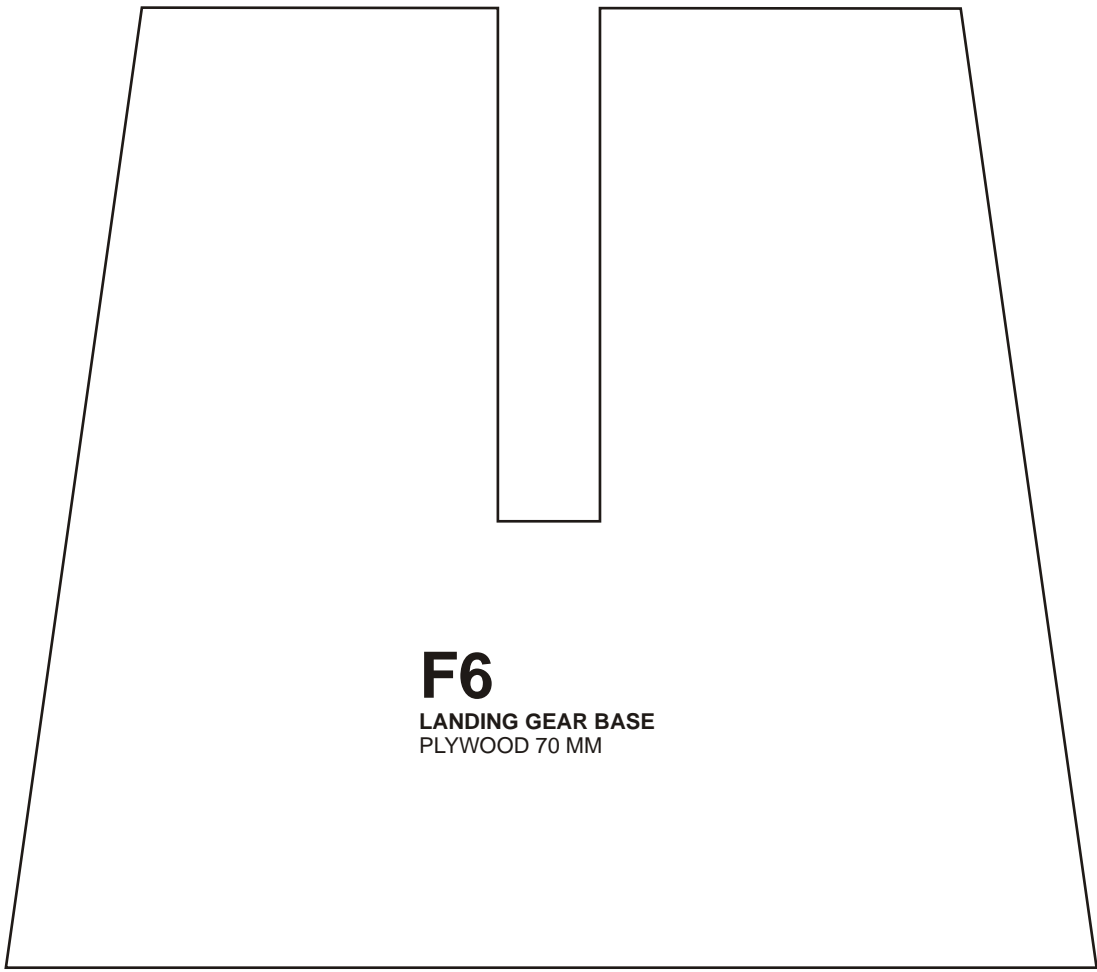

F6
LANDING GEAR BASE
PLYWOOD 70 MM

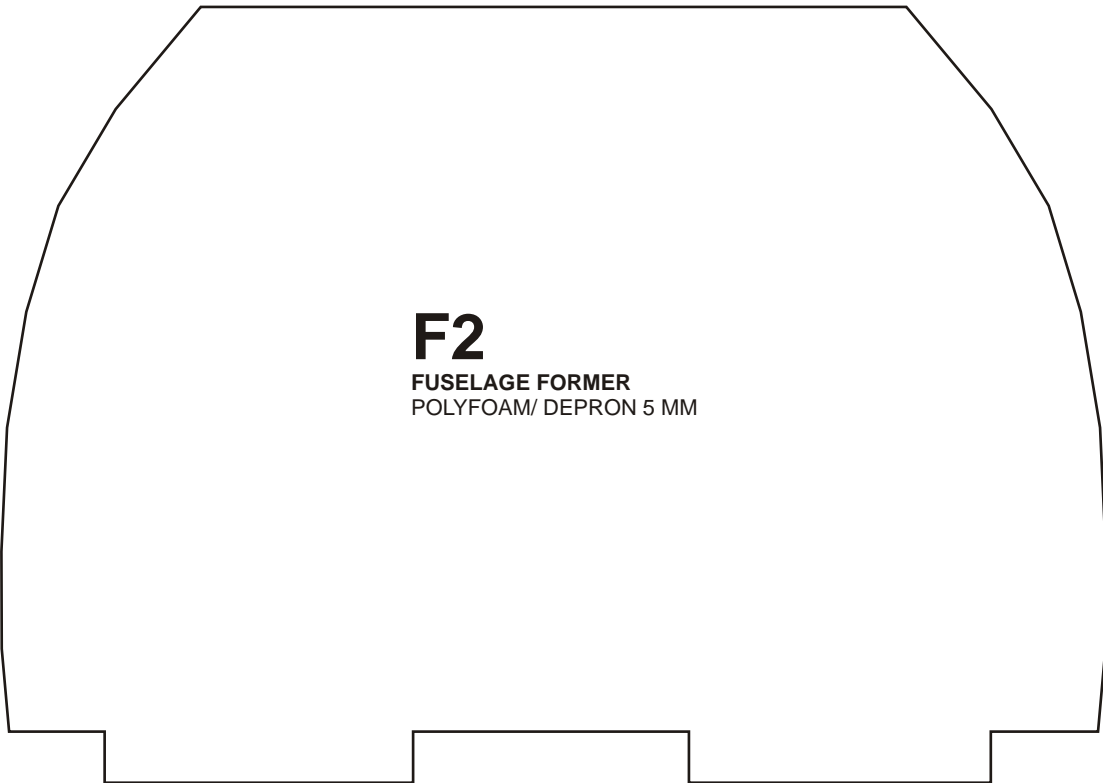

F2
FUSELAGE FORMER
POLYFOAM/ DEPRON 5 MM

F5

FUSELAGE FRAME
POLYFOAM/ DEPRON 5 MM
2X

F3

FUSELAGE FORMER
POLYFOAM/ DEPRON 5 MM

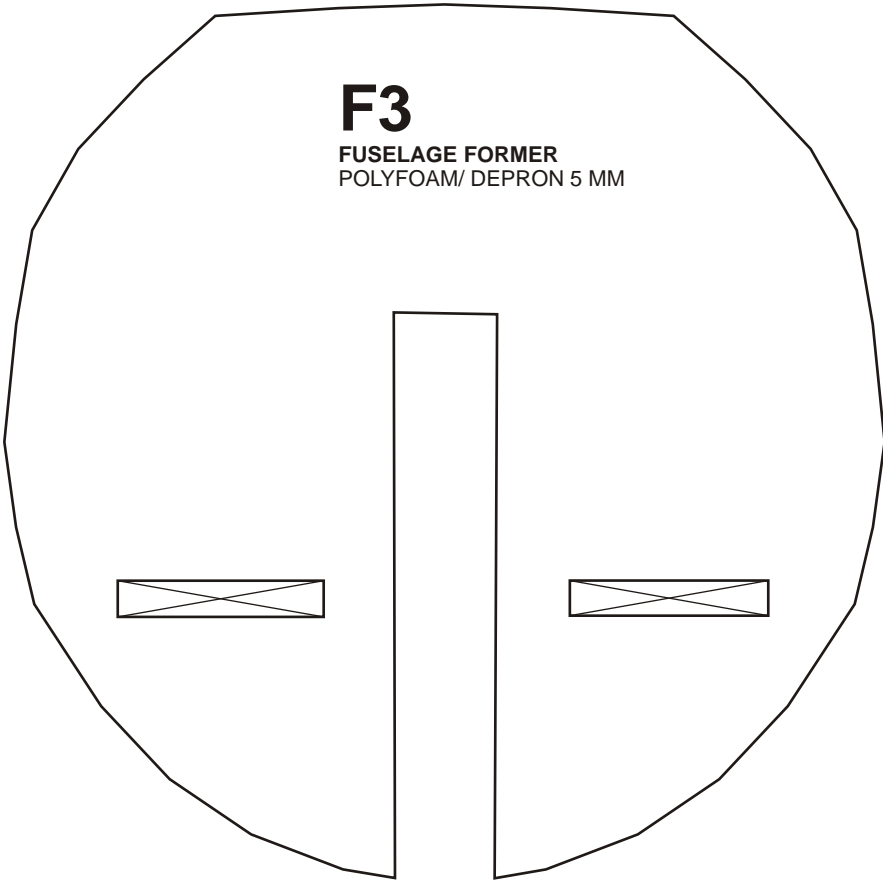

C3

CANOPY
MICA PLASTIC 0.3 MM

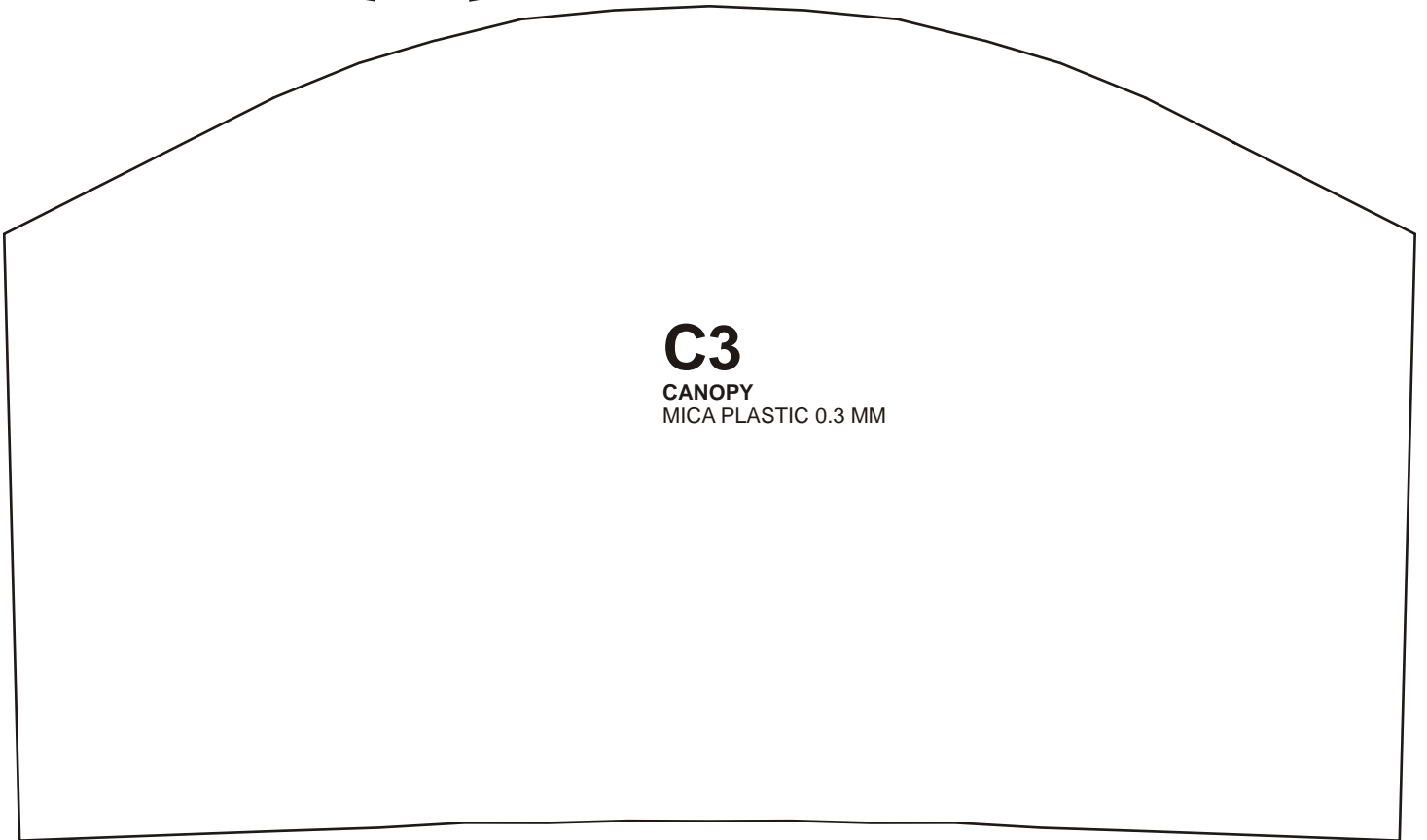



F7

FUSELAGE
POLYFOAM/ DEPRON 3 MM
2X MIRRORED

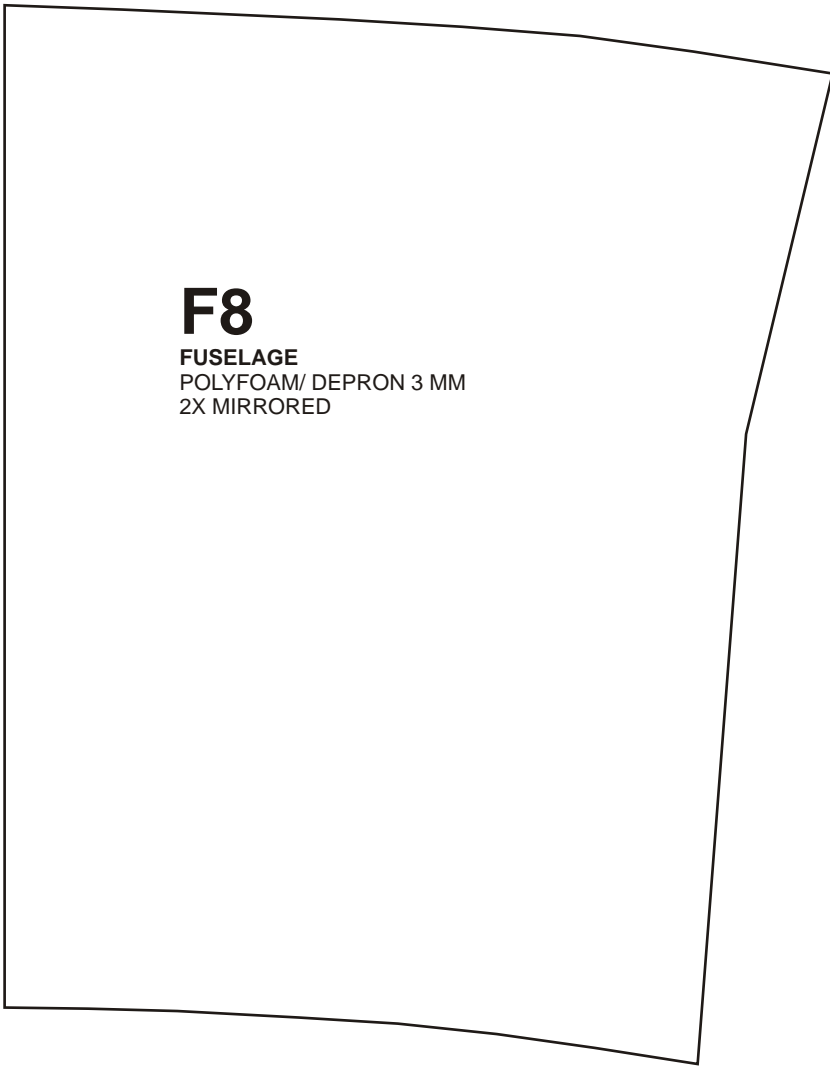

F8

FUSELAGE
POLYFOAM/ DEPRON 3 MM
2X MIRRORED



F12

FUSELAGE FORMER
POLYFOAM/ DEPRON 5 MM

F10

FUSELAGE FRAME
POLYFOAM/
DEPRON 5 MM
2X

FORMER F13

F9

FUSELAGE FRAME
POLYFOAM/ DEPRON 5 MM

JOIN HERE

JOIN HERE

JOIN HERE

JOIN HERE

F9

F10

F13

FUSELAGE FORMER
POLYFOAM/ DEPRON 5 MM

F11

FUSELAGE FORMER
POLYFOAM/
DEPRON 5 MM

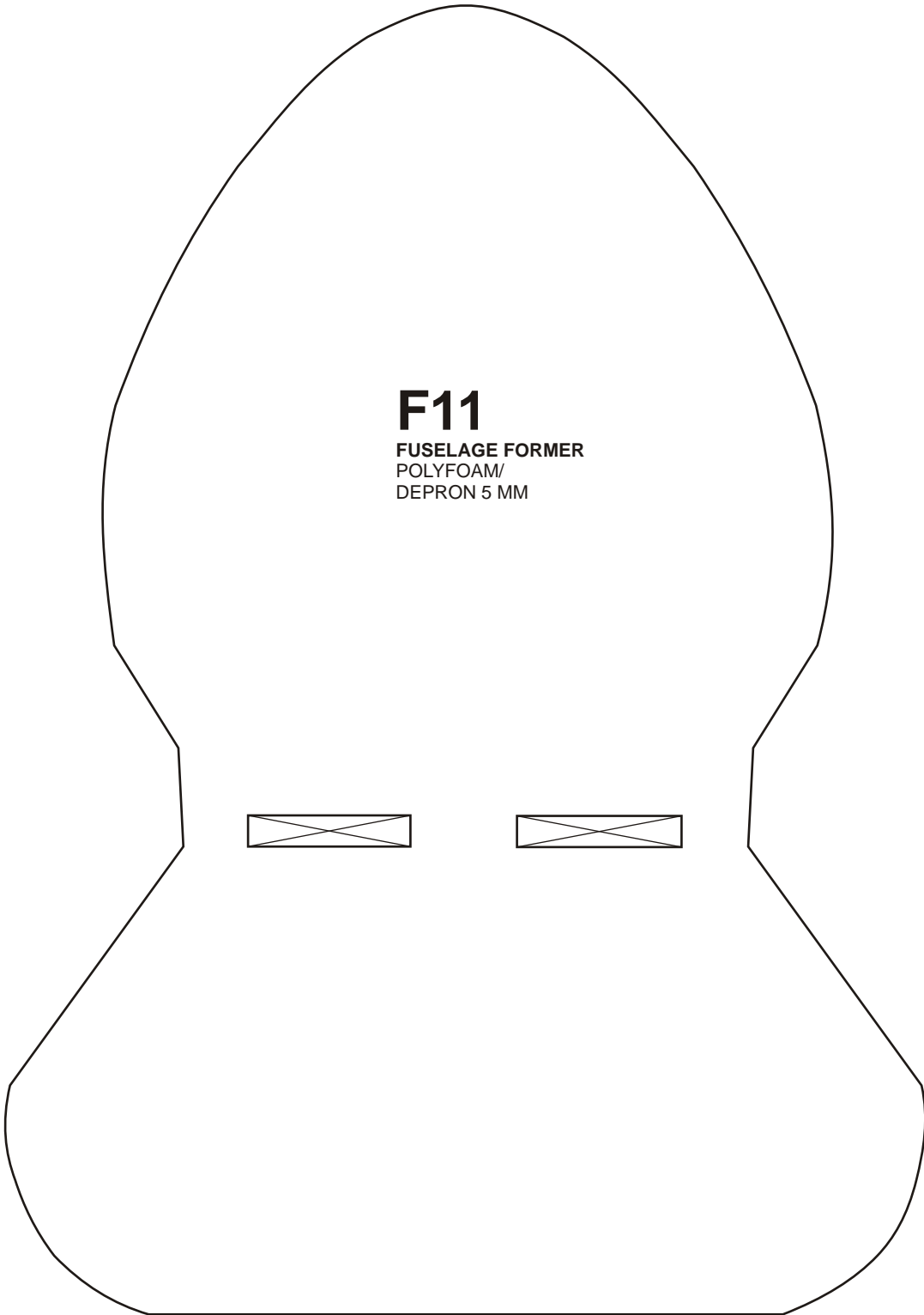

JOIN HERE

F14

FUSELAGE
POLYFOAM/
DEPRON 3 MM
2X MIRRORED

F14

JOIN HERE

F15

FUSELAGE
POLYFOAM/
DEPRON 3 MM

JOIN HERE

JOIN HERE

F15

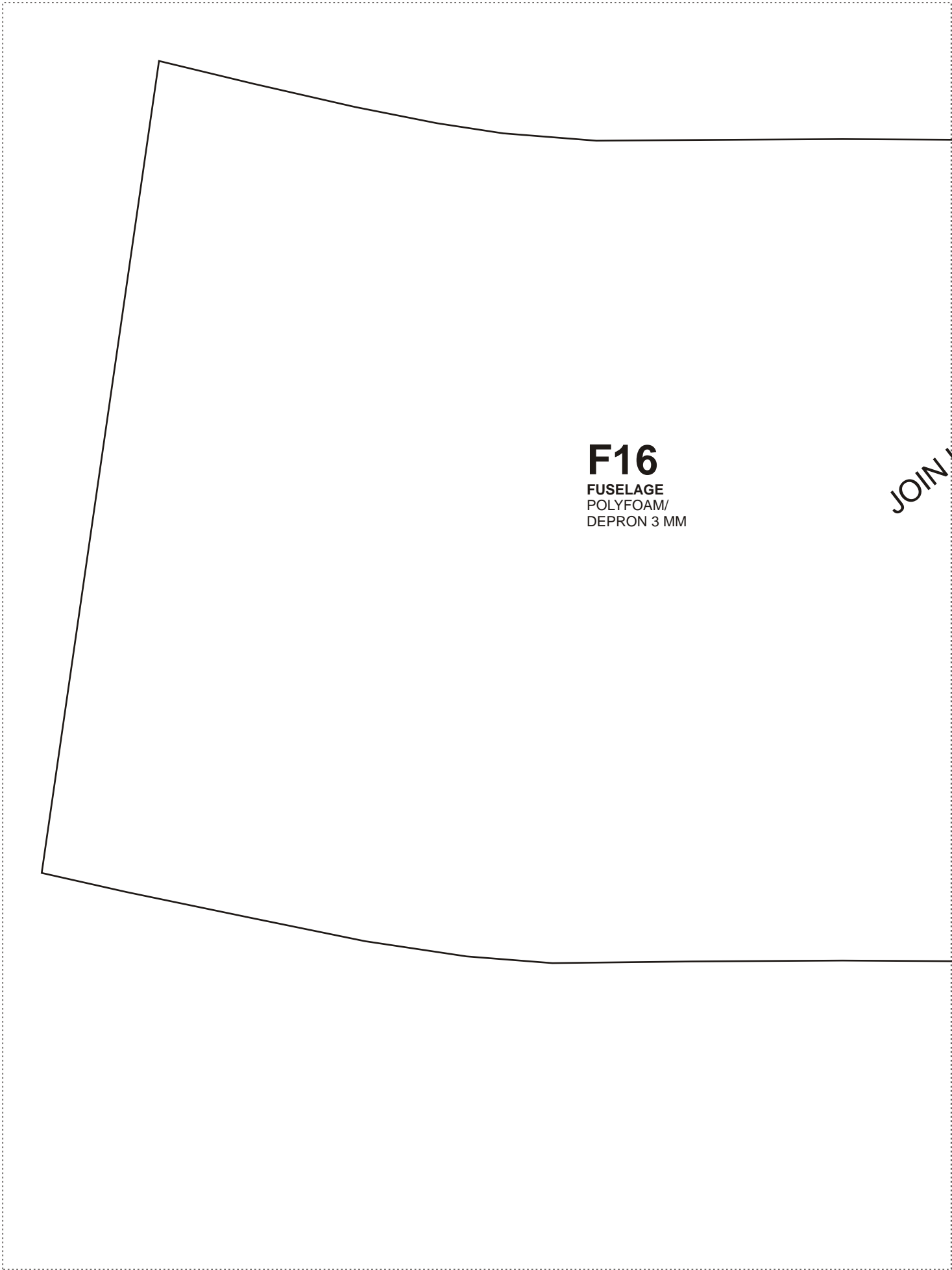

F16

FUSELAGE
POLYFOAM/
DEPRON 3 MM

JOIN HERE

JOIN HERE

F16

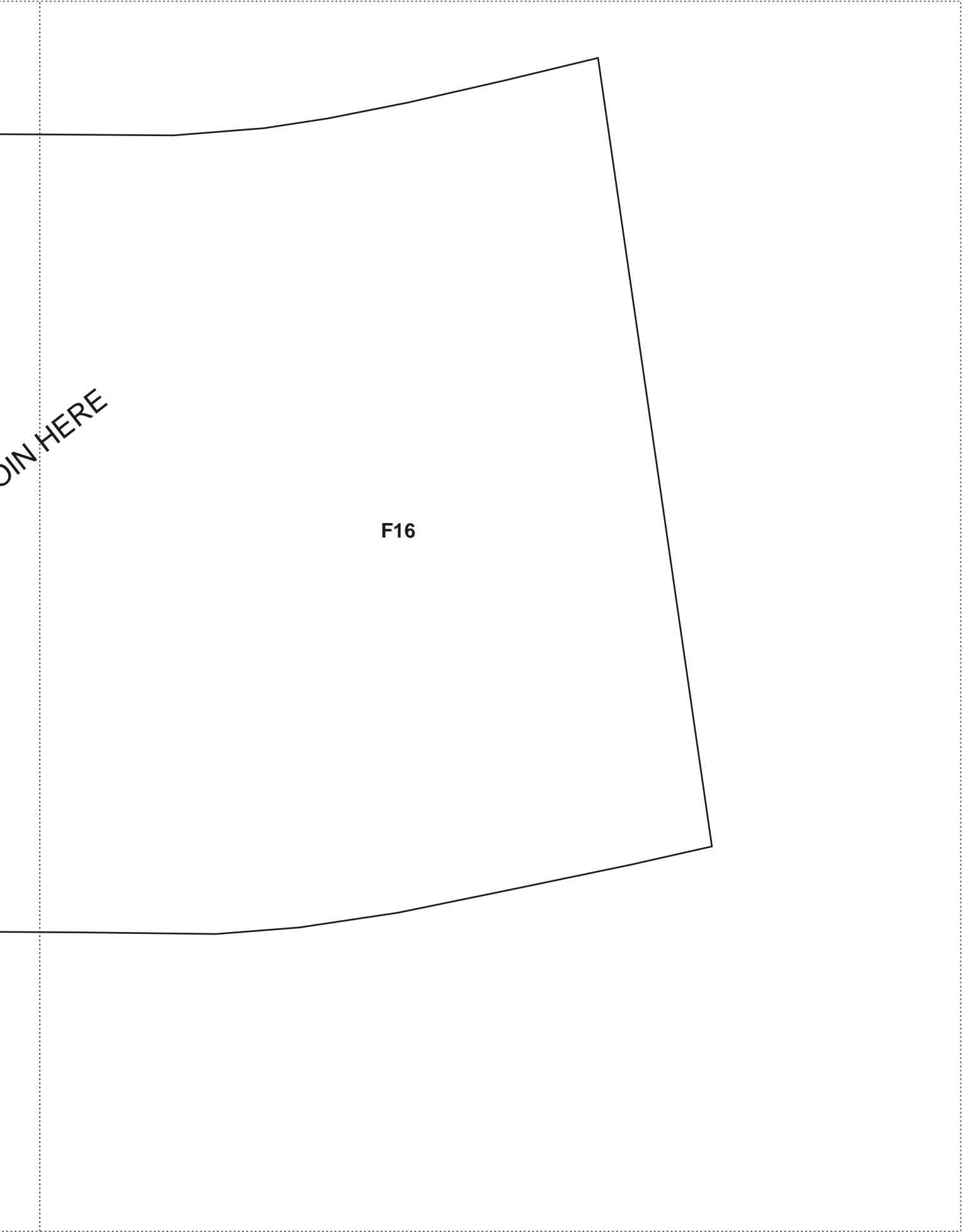

FRONT

TOP

F20

AIR INTAKE
POLYFOAM/
DEPRON 3 MM
2X MIRRORED

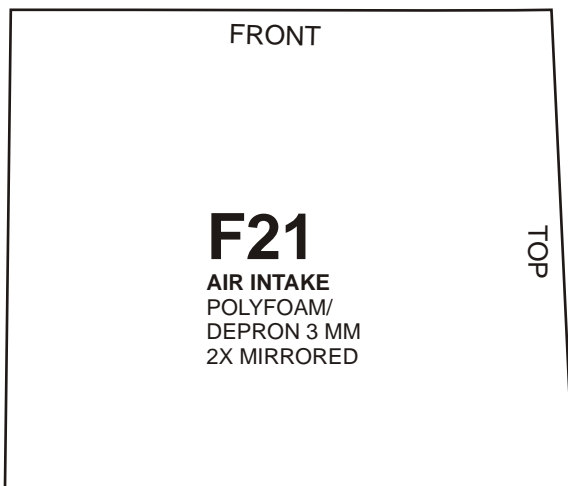
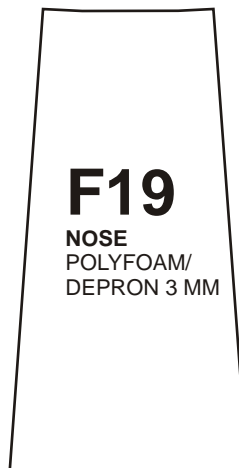
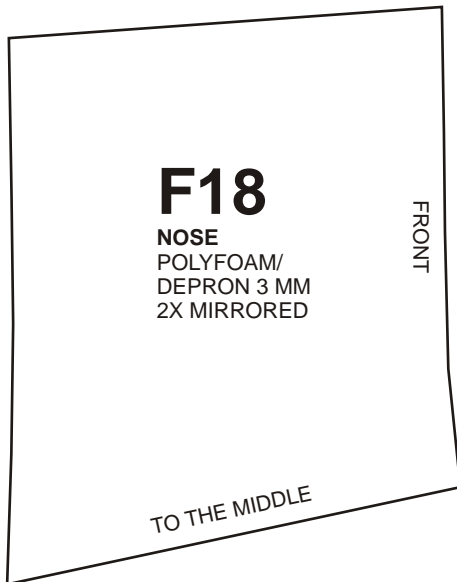
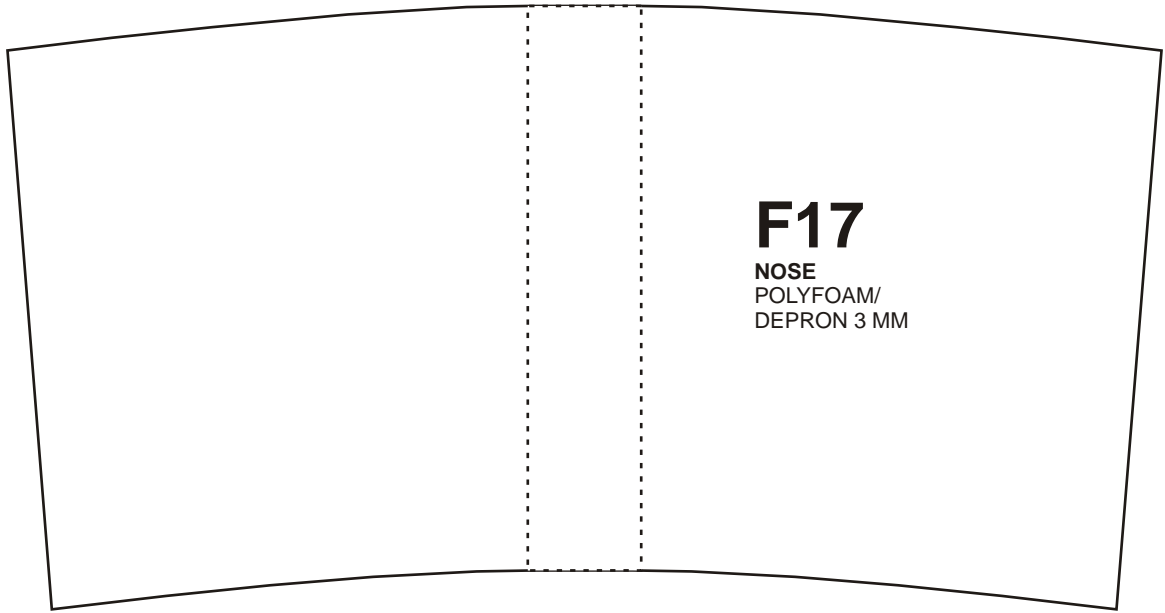



F23

FUSELAGE
POLYFOAM/
DEPRON 3 MM

JOIN HERE

JOIN HERE

F23

F22

FUSELAGE
POLYFOAM/
DEPRON 3 MM
2X MIRRORED

JOIN HERE

JOIN HERE

F22



F24

NOSE
POLYFOAM/
DEPRON 3 MM

F26

NOSE
POLYFOAM/
DEPRON 3 MM

JOIN HERE

JOIN HERE

F24

F25
NOSE
POLYFOAM/
DEPRON 3 MM

F27

TAIL
POLYFOAM/
DEPRON 3 MM

JOIN HERE

JOIN HERE

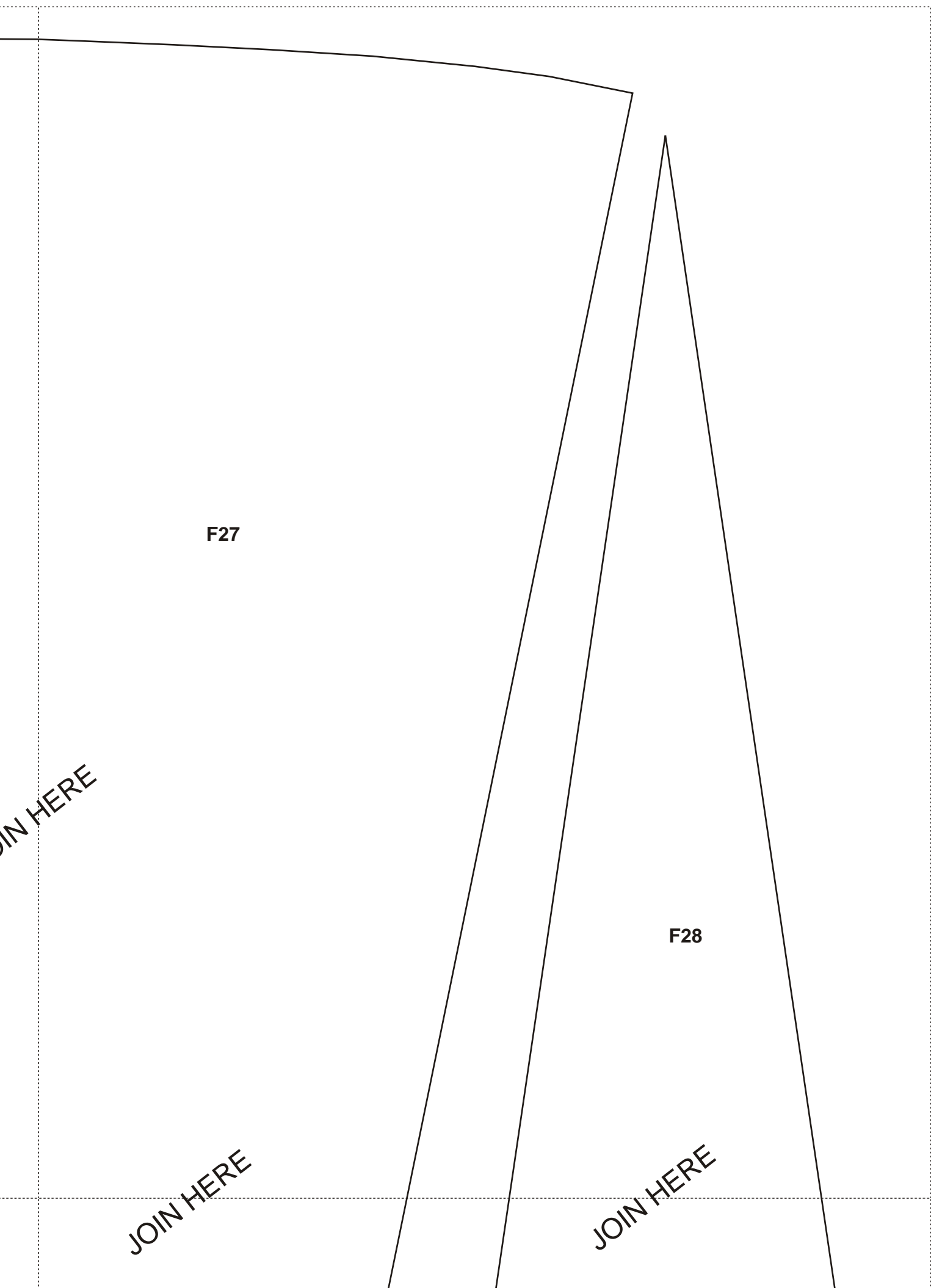

F27

F28

JOIN HERE

JOIN HERE

JOIN HERE

JOIN HERE

F27

JOIN HERE

F29
EXHAUST
POLYFOAM/
DEPRON 5 MM

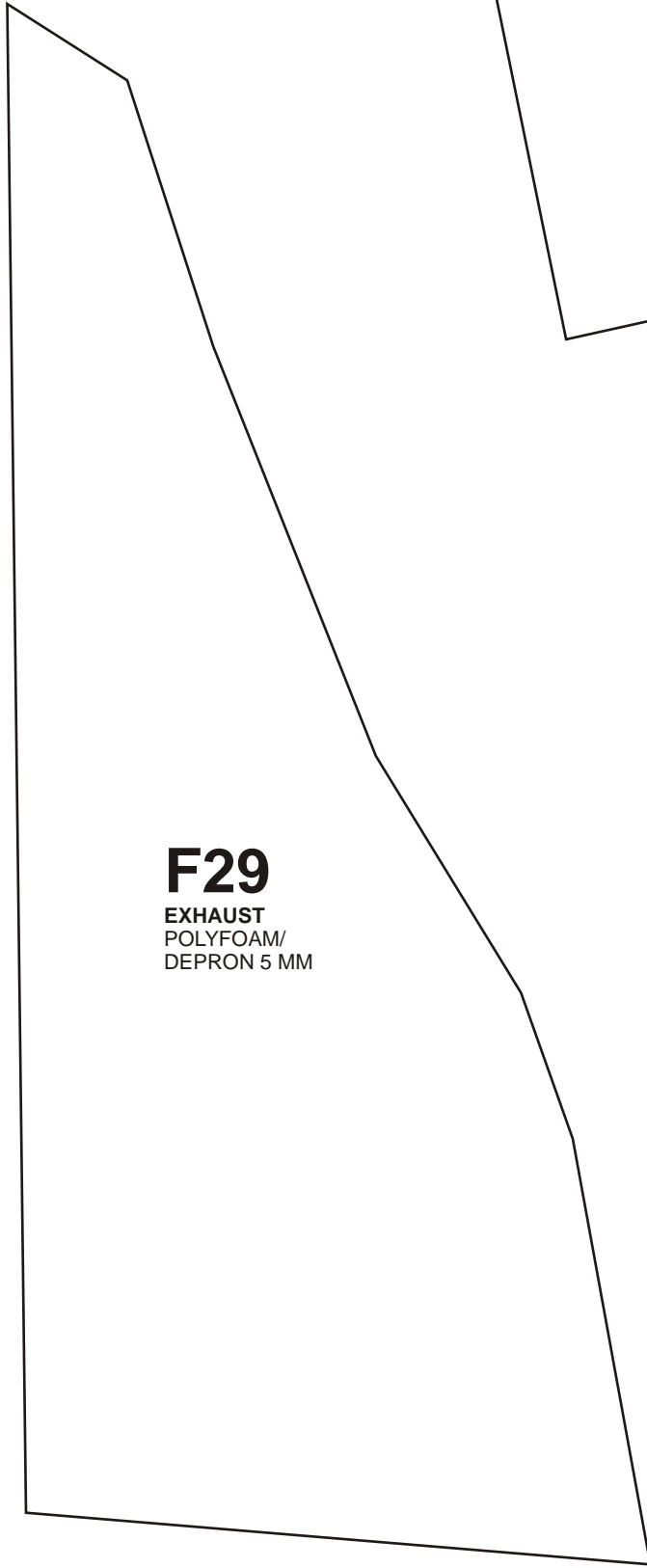

JOIN HERE

JOIN HERE

JOIN HERE

F27

F28

TAIL
POLYFOAM/
DEPRON 5 MM

C4

CANOPY
MICA PLASTIC 0.3 MM

F30

EXHAUST
POLYFOAM/
DEPRON 3 MM
2X MIRRORED

F31

EXHAUST
POLYFOAM/
DEPRON 3 MM
2X MIRRORED

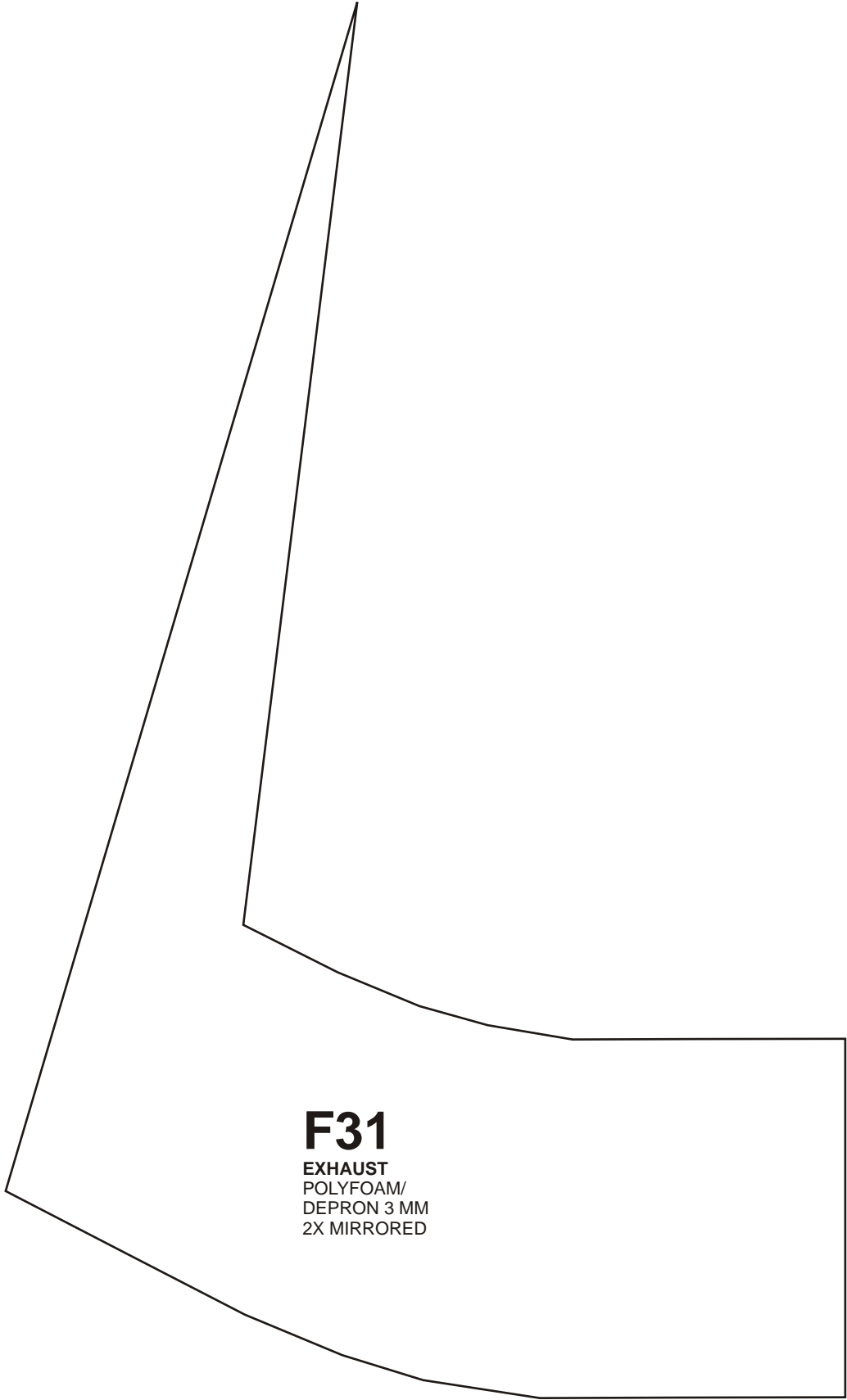

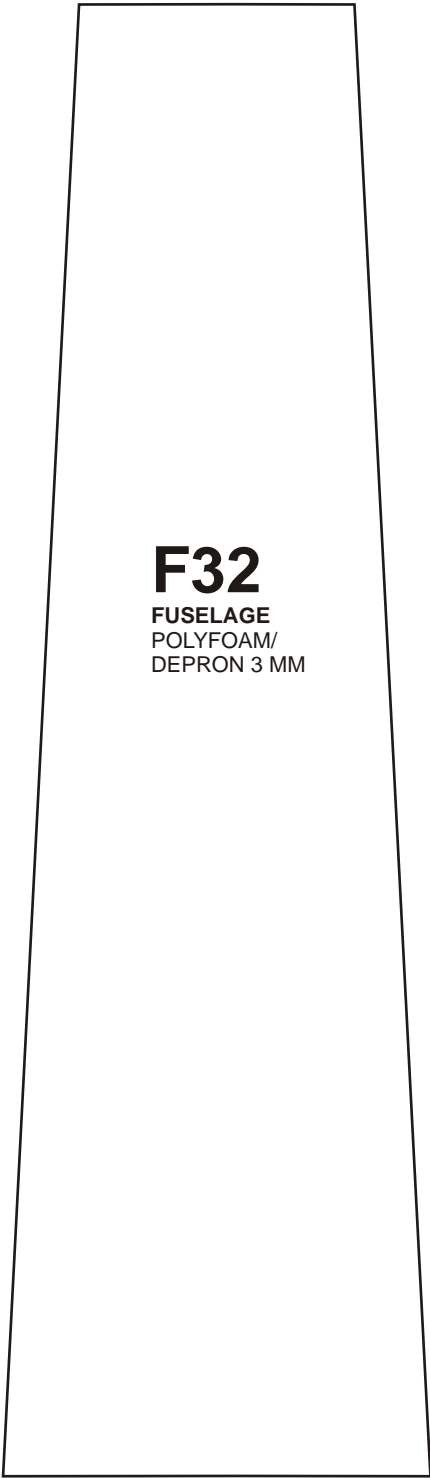

F32
FUSELAGE
POLYFOAM/
DEPRON 3 MM

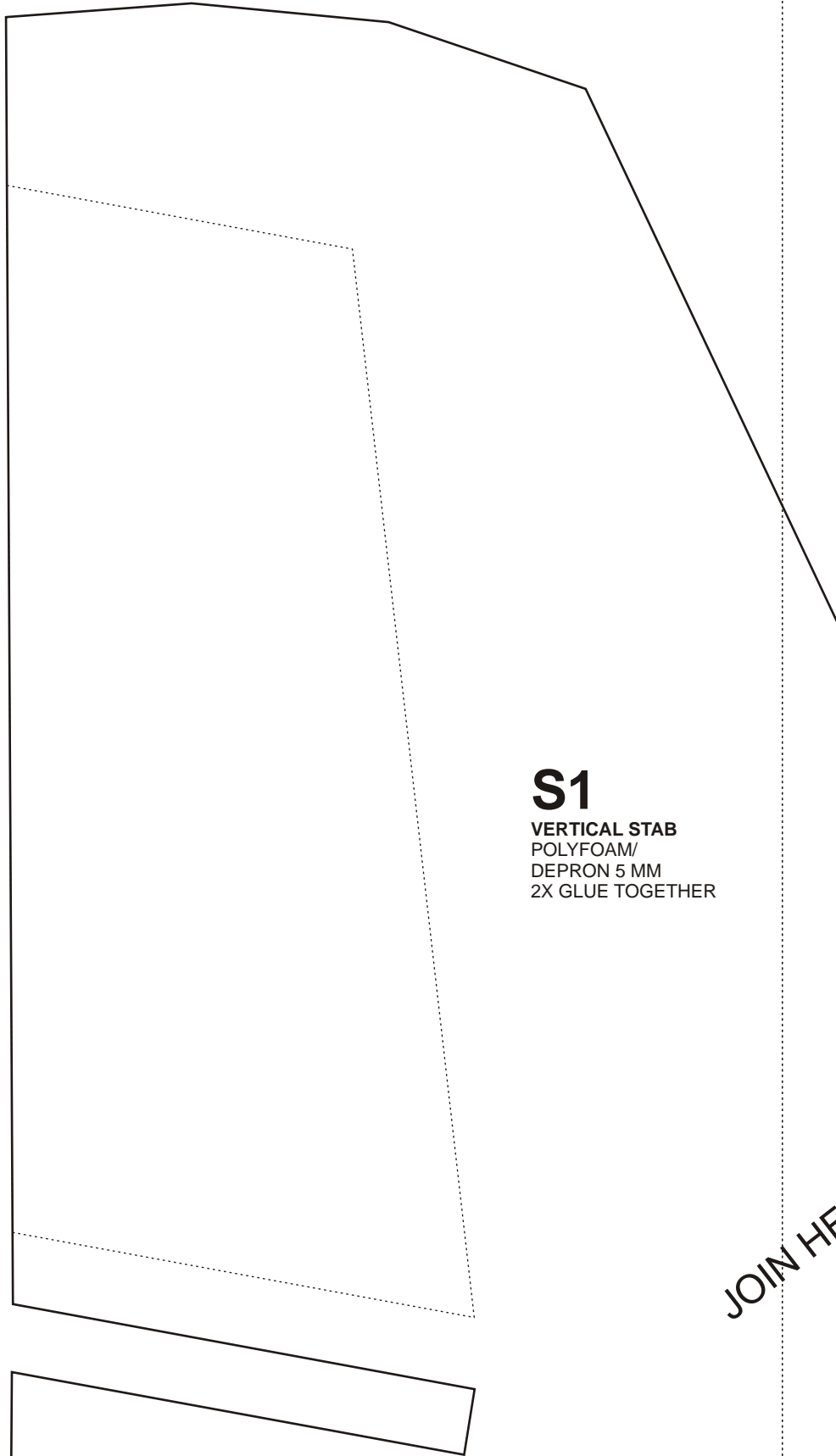

S1
VERTICAL STAB
POLYFOAM/
DEPRON 5 MM
2X GLUE TOGETHER

JOIN HERE

JOIN HERE

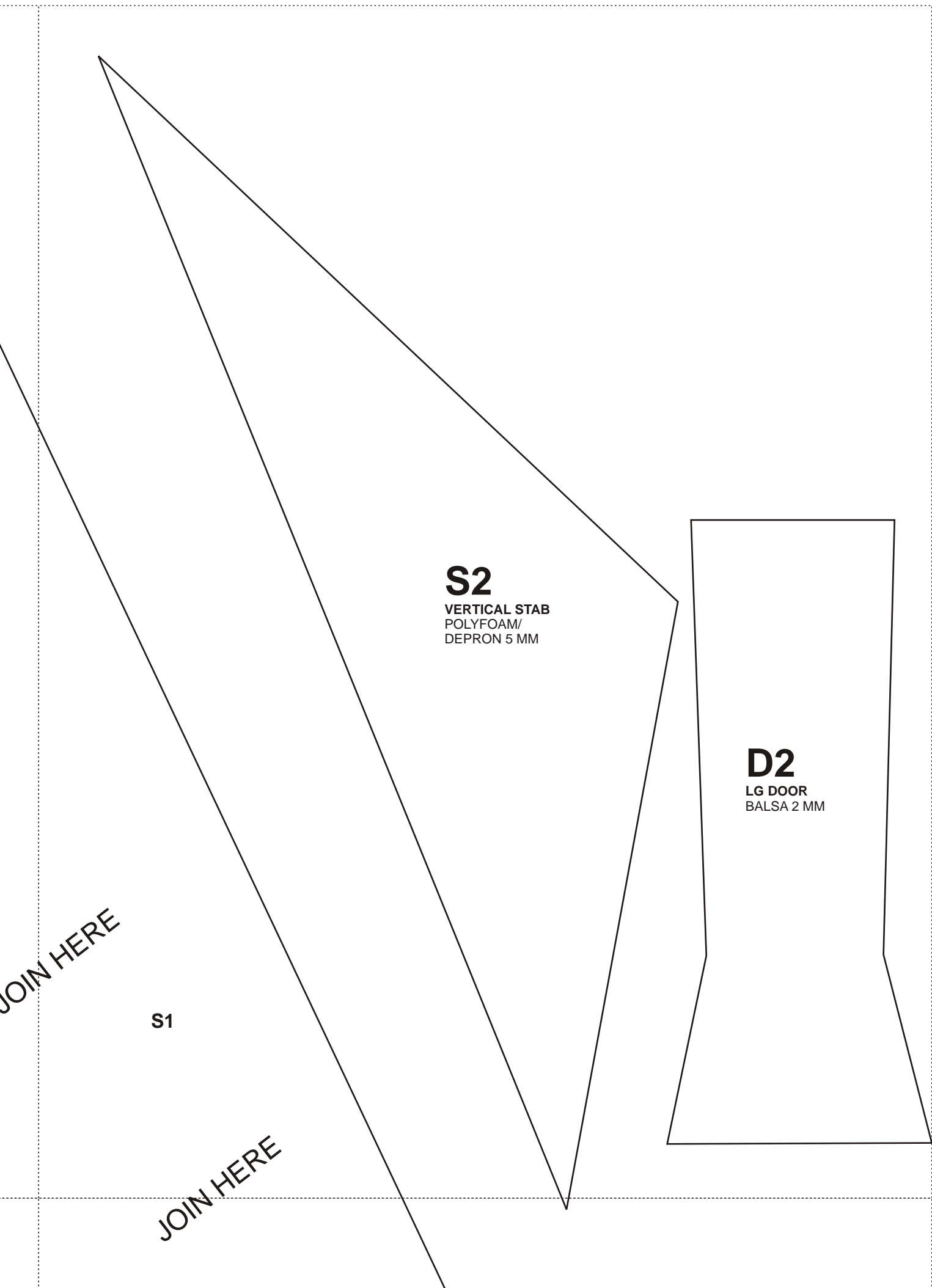

S2

VERTICAL STAB
POLYFOAM/
DEPRON 5 MM

D2

LG DOOR
BALSA 2 MM

S1

JOIN HERE

JOIN HERE

JOIN HERE

S1

JOIN HERE

C5

CANOPY
MICA PLASTIC 0.3 MM

JOIN HERE

JOIN HERE

S1

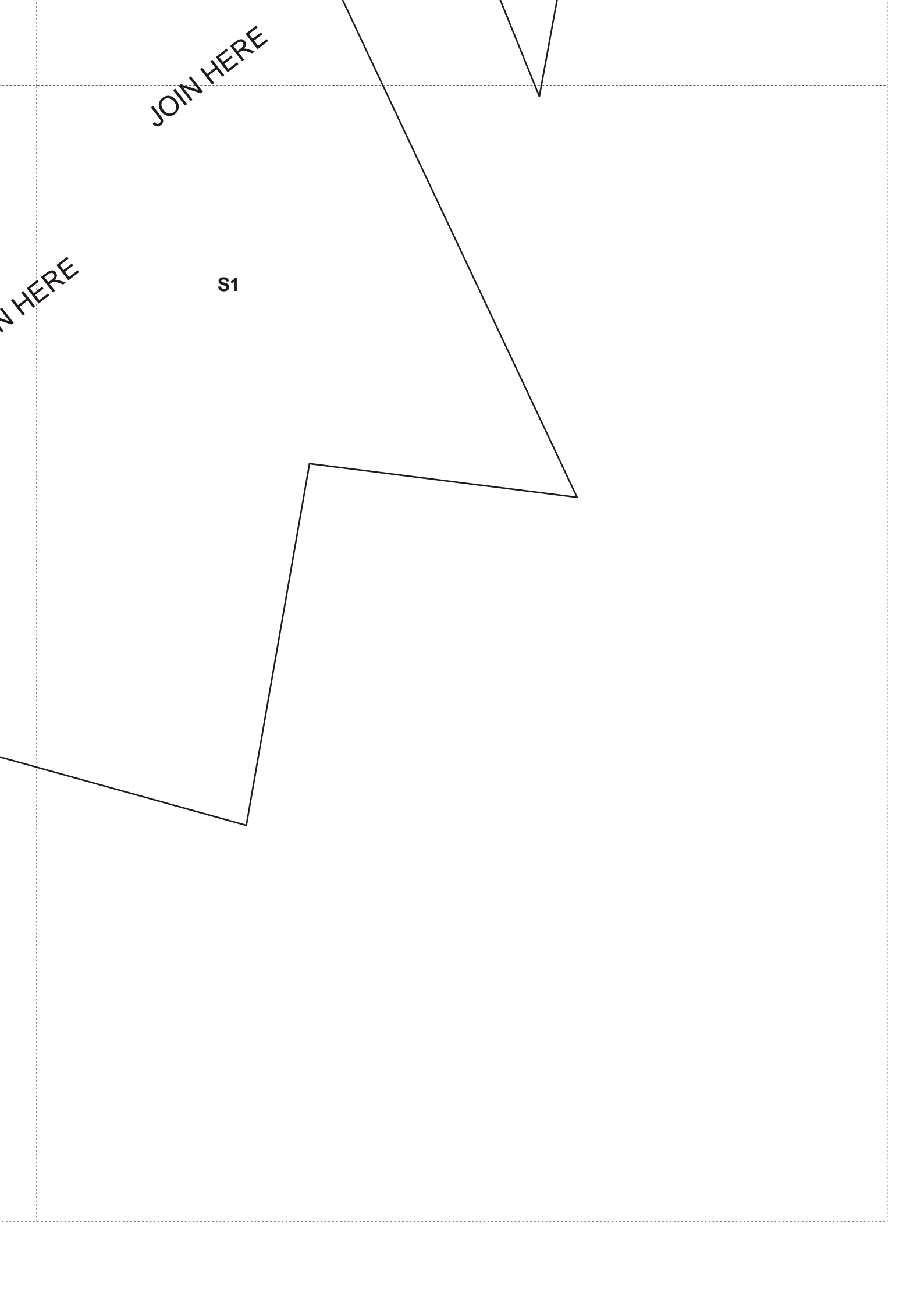

S4

ELEVATOR
POLYFOAM/
DEPRON 5 MM
2X GLUE TOGETHER

S3

HORIZONTAL STAB
POLYFOAM/
DEPRON 5 MM
2X GLUE TOGETHER

JOIN HERE

JOIN HERE

S4

S3

JOIN HERE



JOIN HERE

S4

S3

S5

RUDDER
POLYFOAM/
DEPRON 5 MM
2X GLUE TOGETHER

D1

WING FAIRING
ART CARD 200 GRAM /
MICA PLASTIC 0.3 MM
2X MIRRORED

JOIN HERE

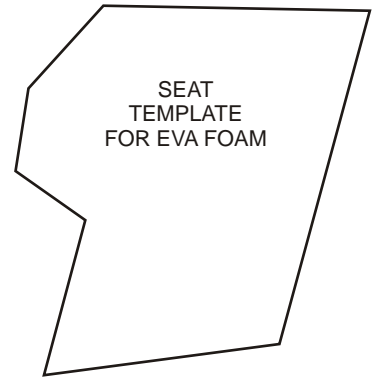
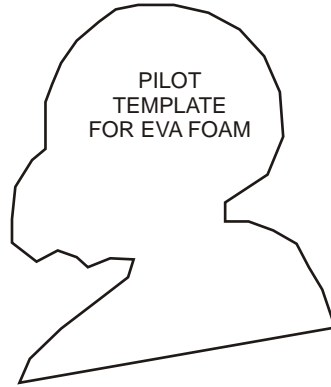

W12

WINGTIP
STYROFOAM BLOCK
50 MM

W12

JOIN HERE