

**F8**  
WING FAIRING  
POLYFOAM  
DEPRON 5MM

**F7**  
WING FAIRING FORMER  
POLYFOAM  
DEPRON 5MM

**F7A**  
WING FAIRING FORMER  
POLYFOAM  
DEPRON 5MM

**F7A**  
WING FAIRING FORMER  
POLYFOAM  
DEPRON 5MM

**F11**  
WING FAIRING FORMER  
POLYFOAM  
DEPRON 5MM

**F14/F7**  
WING FAIRING FORMER  
POLYFOAM  
DEPRON 5MM

**F19**  
WING FAIRING  
POLYFOAM  
DEPRON 5MM

**W2**  
WING CENTER BEAM  
POLYWOOD  
3mm

**W5**  
WING CENTER BEAM  
POLYWOOD  
3mm

**F17**  
WING FAIRING  
POLYFOAM  
DEPRON 5MM



## Boeing 747-400 4000mm Part 2

- Specs :**
- 1. Wingspan 4000mm / 157.5 inches
  - 2. Flying weight : target 4000 grams
  - 3. Wing loading :
  - 4. Wing cable loading :
  - 5. Wing Area :
  - 6. CG :

**Electronics**  
- 1 metal gear 9 gram servos (micro servo)

- Materials :**
- 1. 5mm + 3mm Depron Polyfoam
  - 2. 3mm Plywood / PVC foam board
  - 3. hot glue, foam-safe glue, CA glue
  - 4. packing tape

**Build Instructions :**  
1. paper-replika.com  
2. youtube channel : Julius Perdana

**F10**  
WING FAIRING  
POLYFOAM  
DEPRON 3MM

**F13**  
WING FAIRING  
POLYFOAM  
DEPRON 3MM

**F15**  
WING FAIRING FORMER  
POLYFOAM  
DEPRON 3MM

**F16**  
WING FAIRING  
POLYFOAM  
DEPRON 3MM

**W4**  
WING CENTER BEAM  
PVC FOAMBOARD 3MM/  
PLYWOOD 3MM  
X2

**F19**  
WING FAIRING  
POLYFOAM  
DEPRON 3MM

**G7**  
PVC FOAMBOARD 3MM  
X4

**G1**  
LANDING GEAR MOUNTING  
PVC FOAMBOARD 3MM  
BX

**G5**  
LANDING GEAR BOOGIE  
PVC FOAMBOARD 3MM/  
PLYWOOD 3MM  
X8

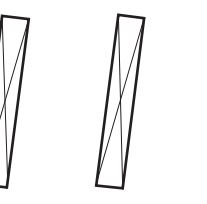
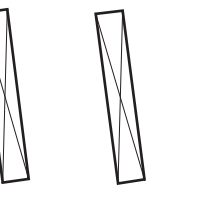
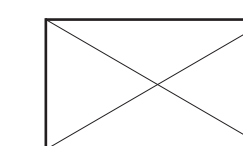

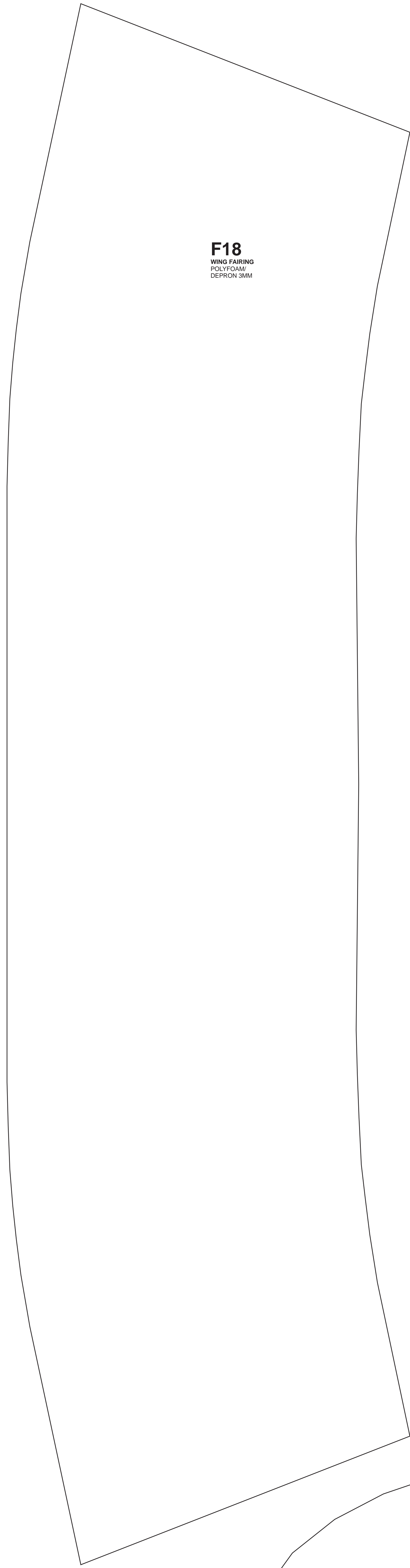

**F18**  
WING FAIRING  
POLYFOAM  
DEPRON 3MM

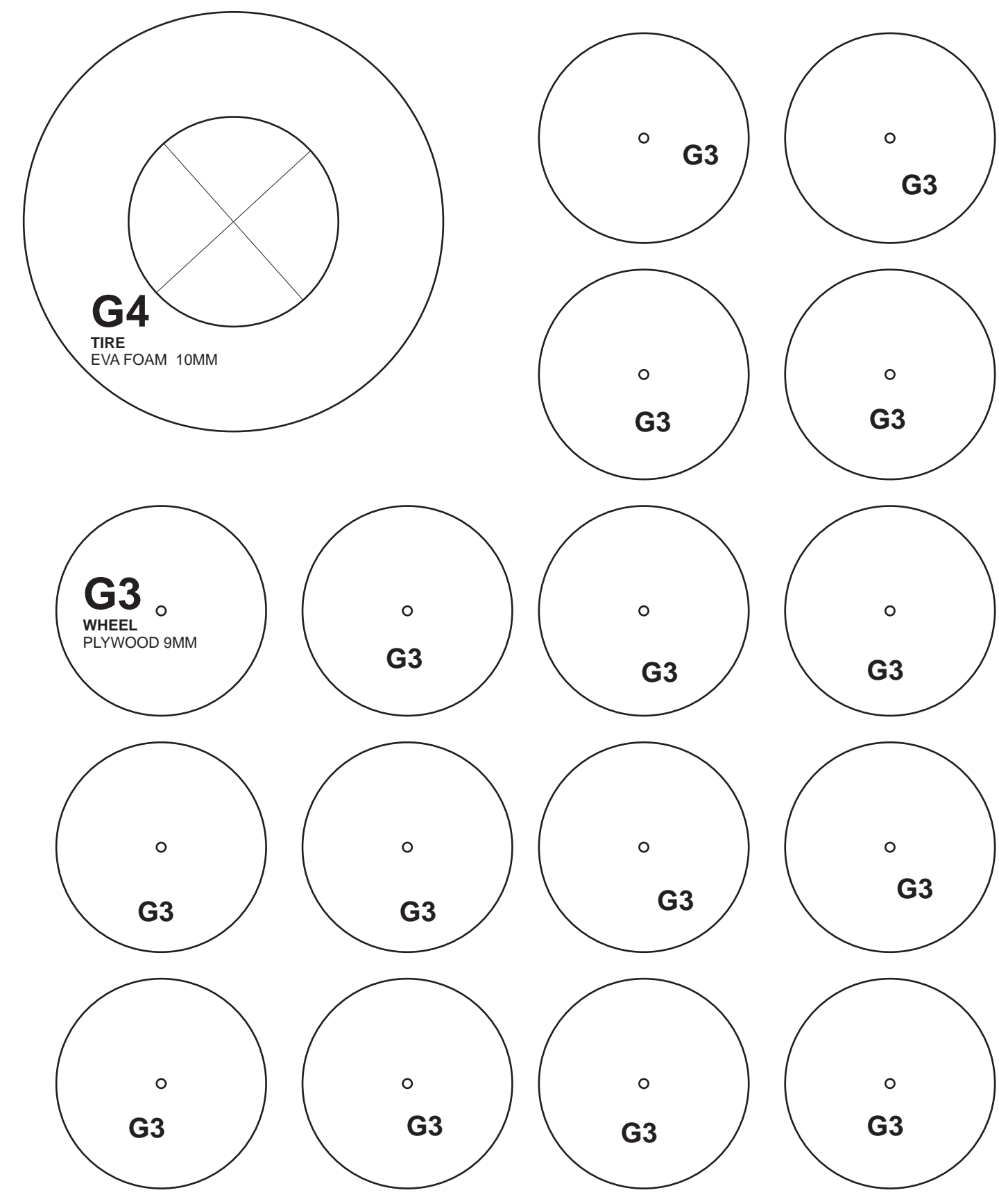

**G4**  
TIRE  
EVAFOAM 10MM

**G3**  
WHEEL  
PLYWOOD 9MM

**G3**

**G3**

**G3**

**G3**

**G3**

**G3**

**G3**

**G3**

**G3**

**G3**

**G3**

**G3**

**G3**

**G3**

**G3**

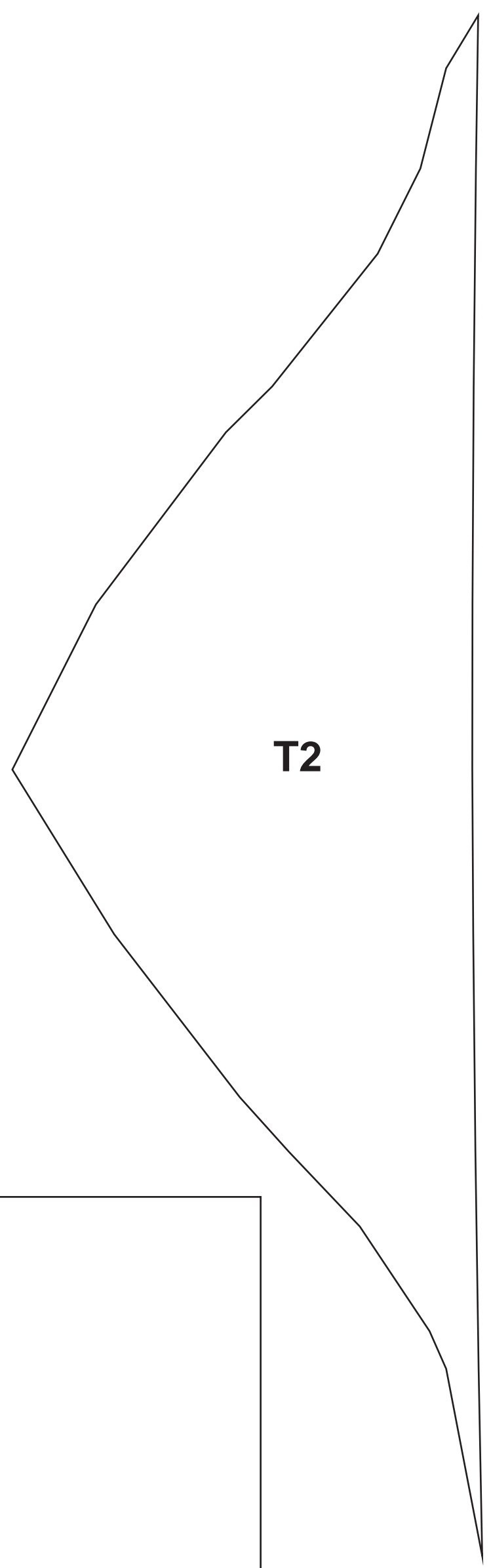

**T2**

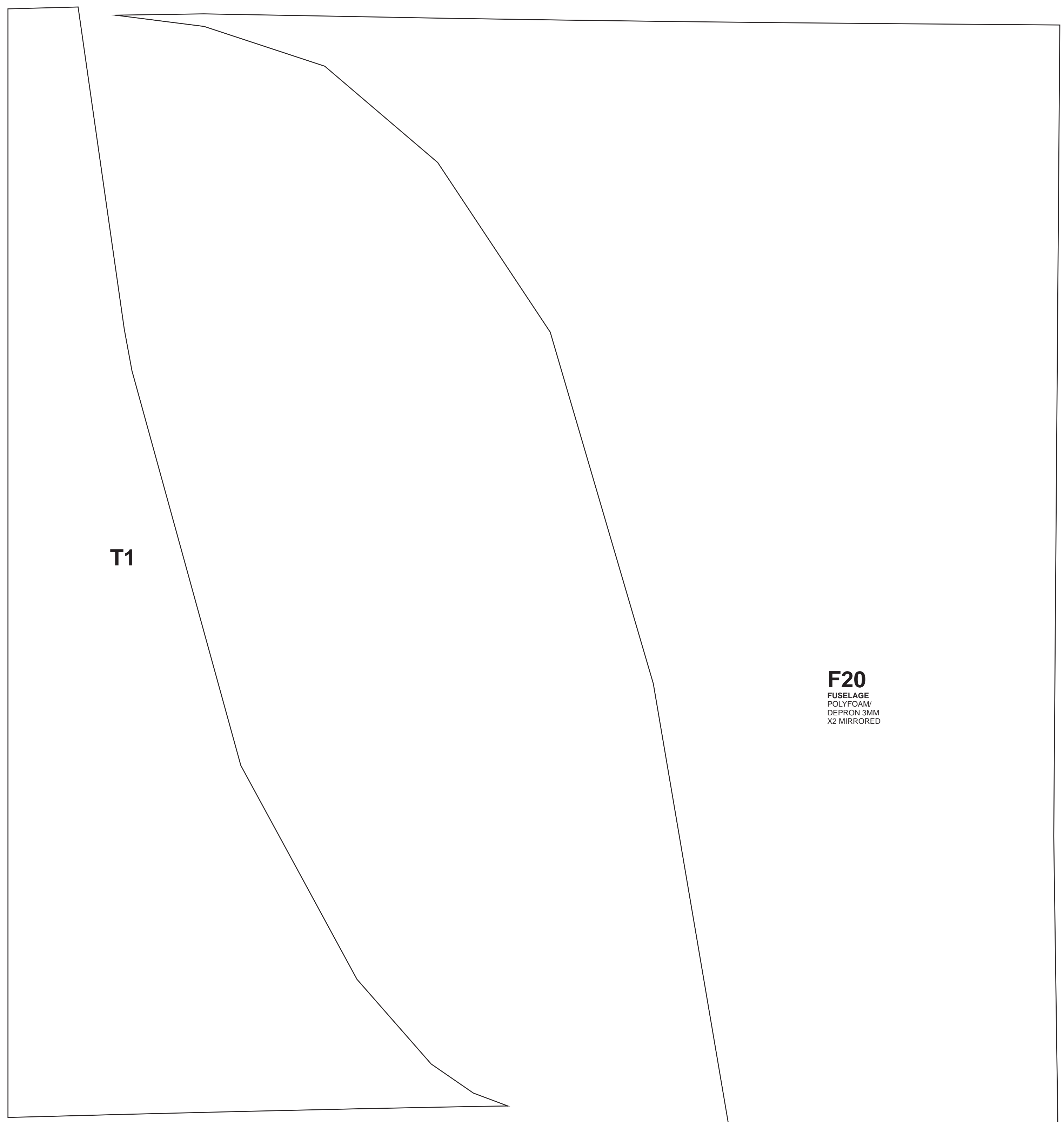

**T1**

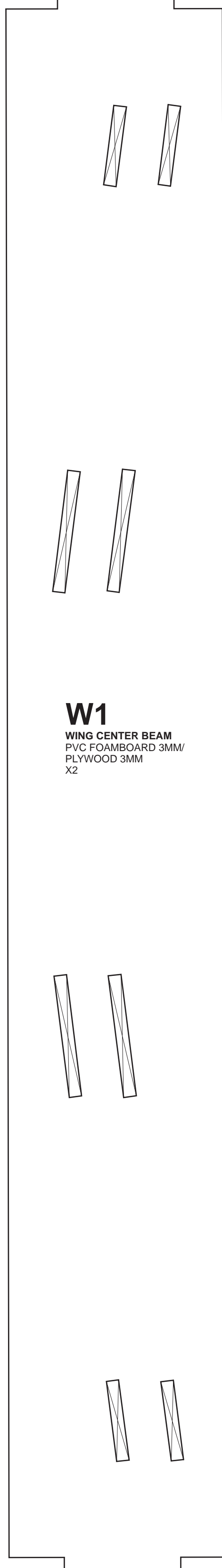

**W1**  
WING CENTER BEAM  
PVC FOAMBOARD 3MM  
PLYWOOD 3MM  
X2

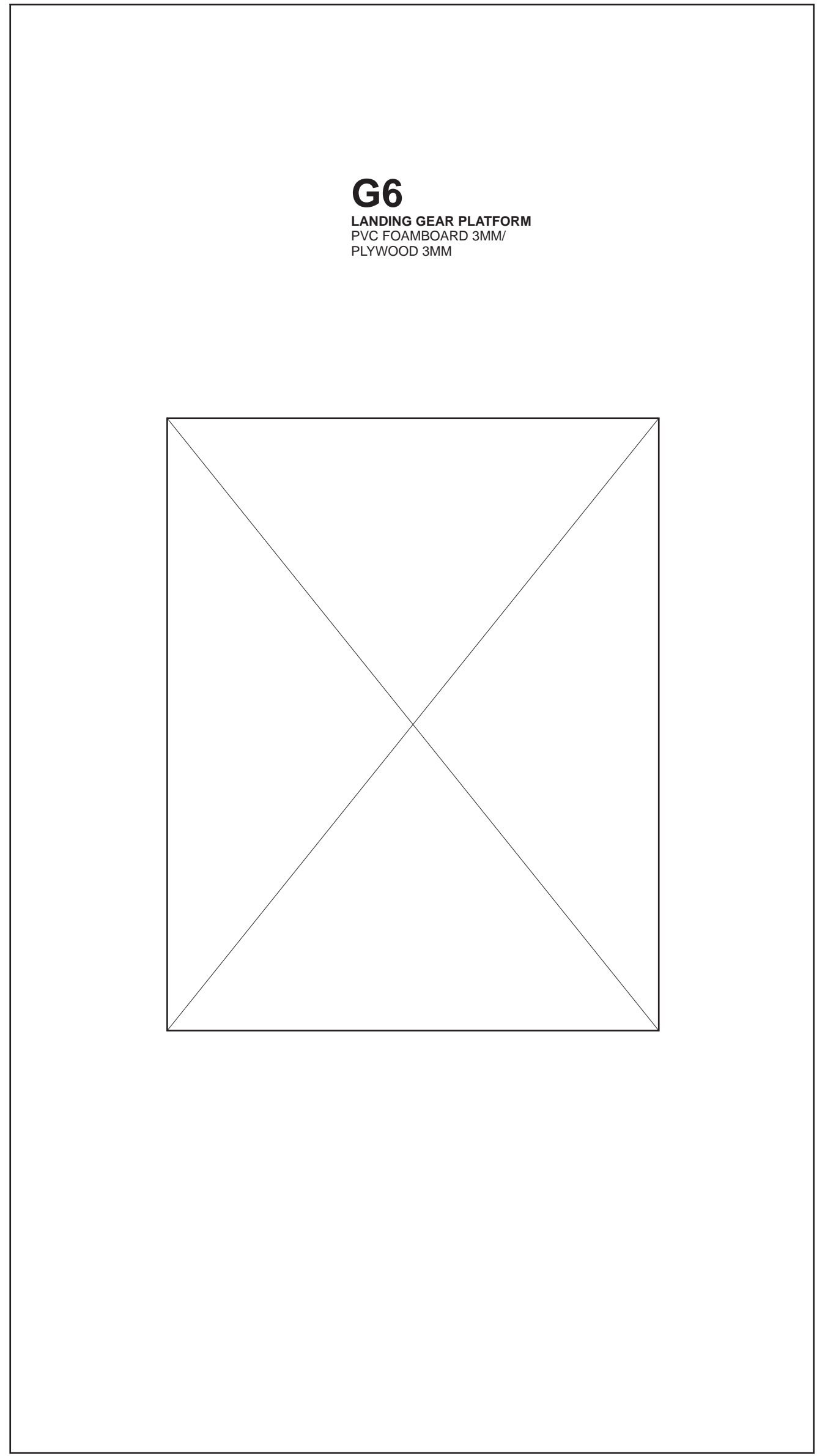

**G6**  
LANDING GEAR PLATFORM  
PVC FOAMBOARD 3MM/  
PLYWOOD 3MM

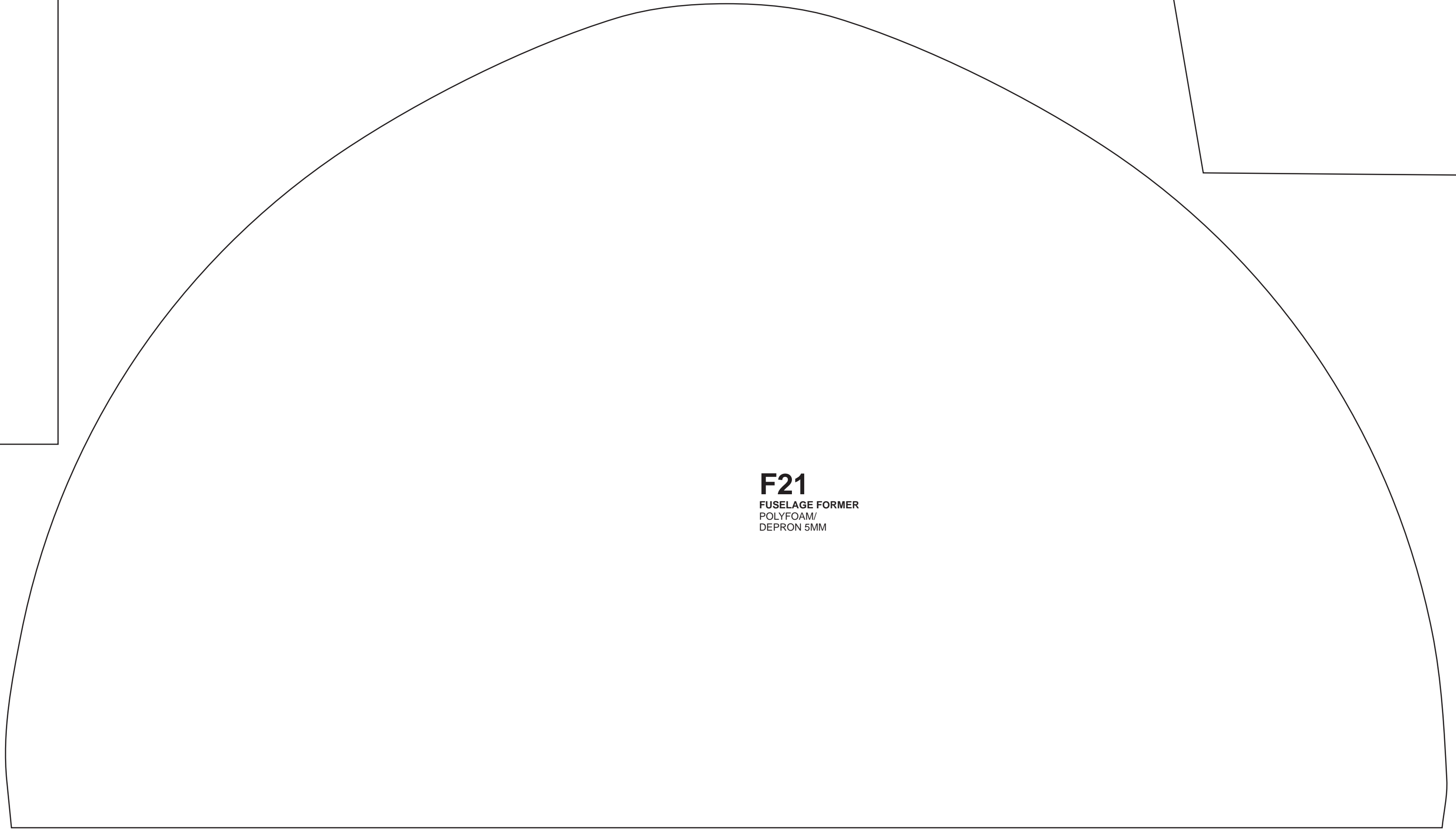

**F21**  
FUSELAGE FORMER  
POLYFOAM  
DEPRON 3MM

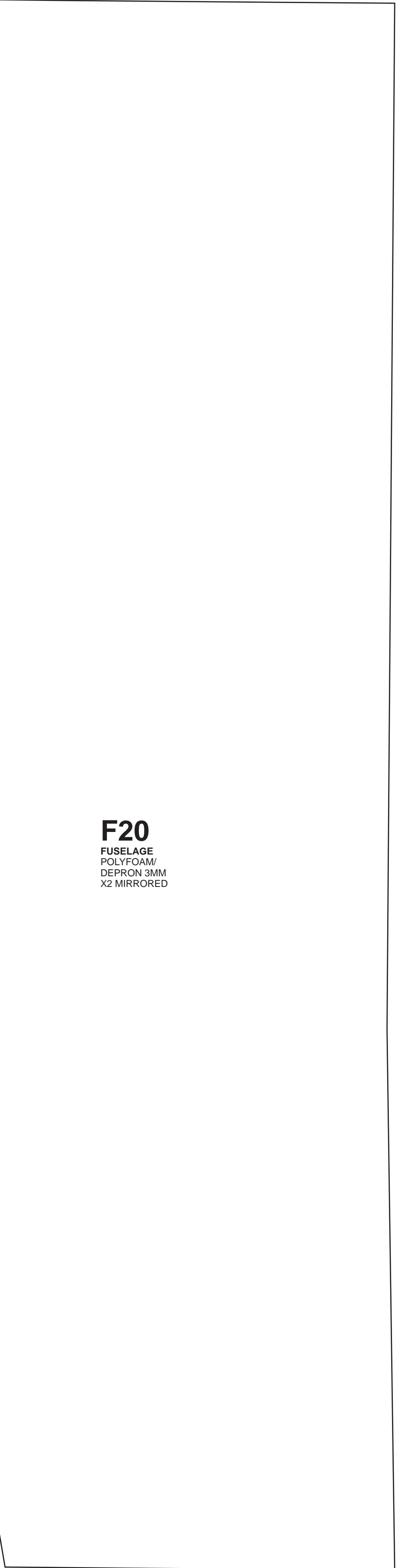

**F20**  
FUSELAGE  
POLYFOAM  
DEPRON 3MM  
X2 MIRRORRED

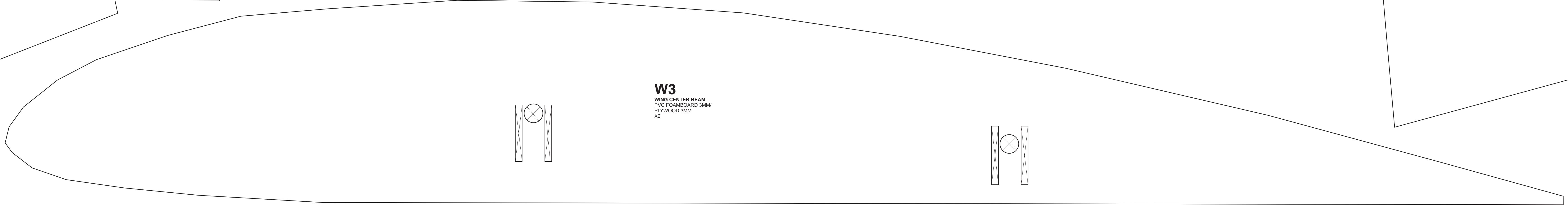

**W3**  
WING CENTER BEAM  
PVC FOAMBOARD 3MM  
PLYWOOD 3MM  
X2

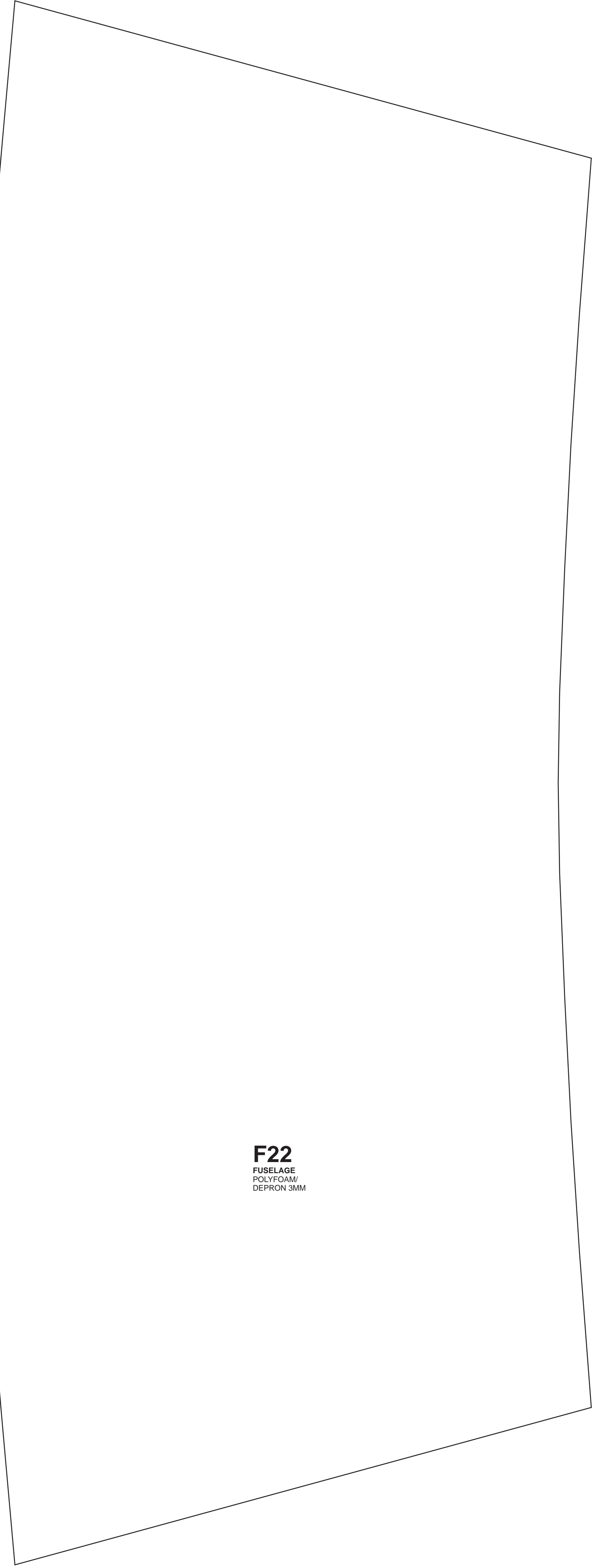

**F22**  
FUSELAGE  
POLYFOAM  
DEPRON 3MM



