



Model : 22/2021



Mirage 2000

950mm

Specs :

1. Wingspan 950mm / 37.5 inches
2. Flying weight : 1480 grams/ 52.2 oz
3. Wing loading : 33.2 gram/dm² - 10.9 oz/sq.ft.
4. Wing cube loading : 5
5. Wing Area : 44.6 dm² / 691 sq.in.
6. CG : 4.5 cm to the back from 2nd seam, which started from air intake

Electronics

(Pusher)

- Tested with 2836 2700kv brushless motor with 6X4 propeller
- 80A ESC
- Battery Lipo 4S 2200mah
- 3 metal gear 9 gram servos (micro servo)

(Recommended EDF)

- FMS 70mm EDF 12 blades
- 80A ESC
- 2X 3S 2200mah / 6S 2200mah

Materials :

1. 5mm Foamboard/ Depron/ Polyfoam
2. 3mm Plywood / PVC foam board
3. 0.5mm Mica Plastic
4. hot glue, UHU glue, CA glue
5. packing tape/ laminating film

Build Instructions :

1. paper-replika.com
2. youtube channel : Julius Perdana

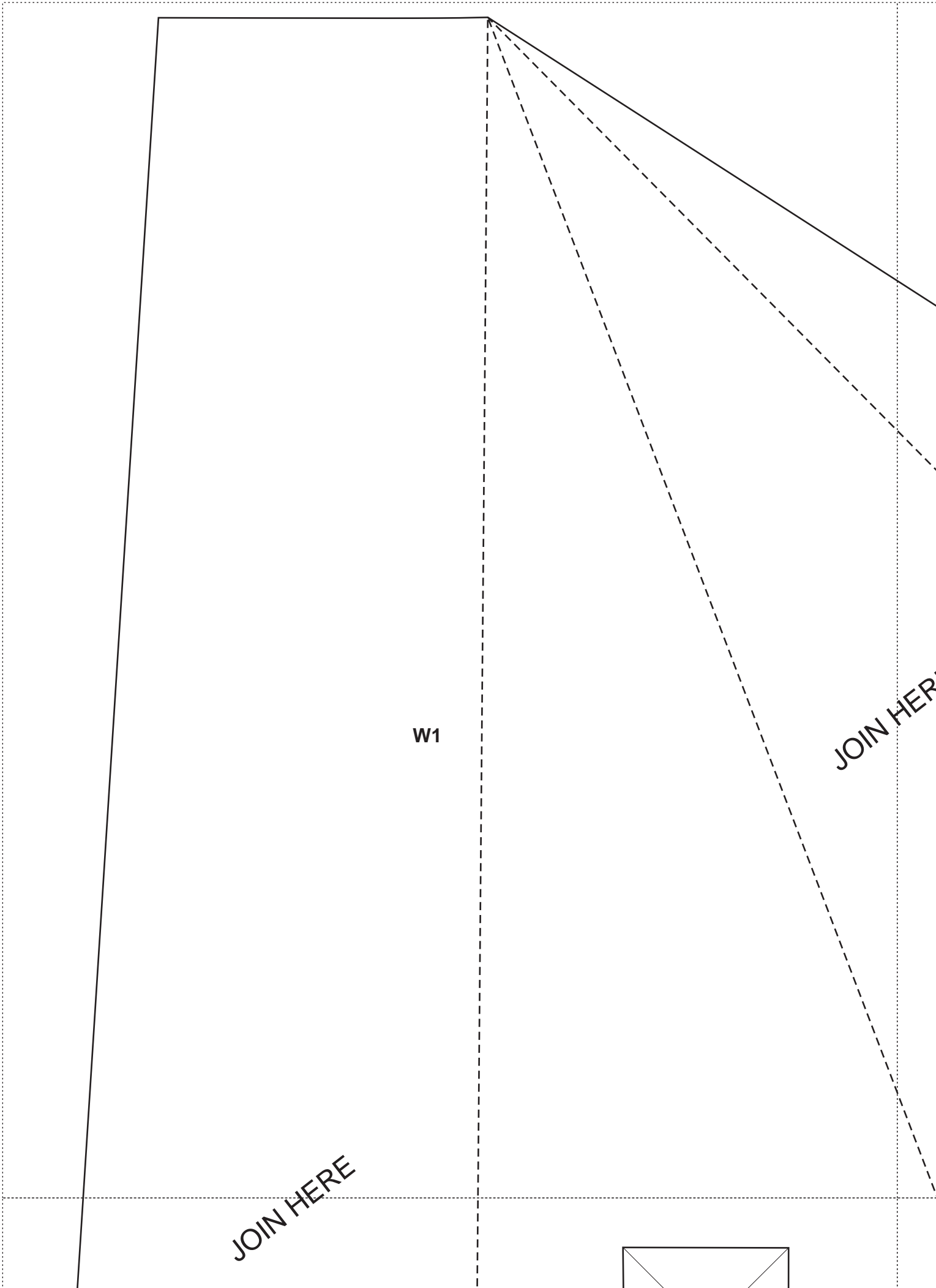

JOIN HERE

W1

JOIN HERE

JOIN HERE

JOIN HERE

T1
ELEVON
TRACE

W1

JOIN HERE

JOIN HERE

JOIN HERE

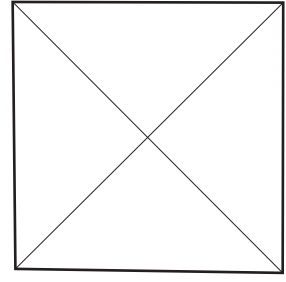

W1

JOIN HERE

JOIN HERE

JOIN HERE

W1

WING
POLYFOAM/ DEPRON 3MM
2X MIRRORED

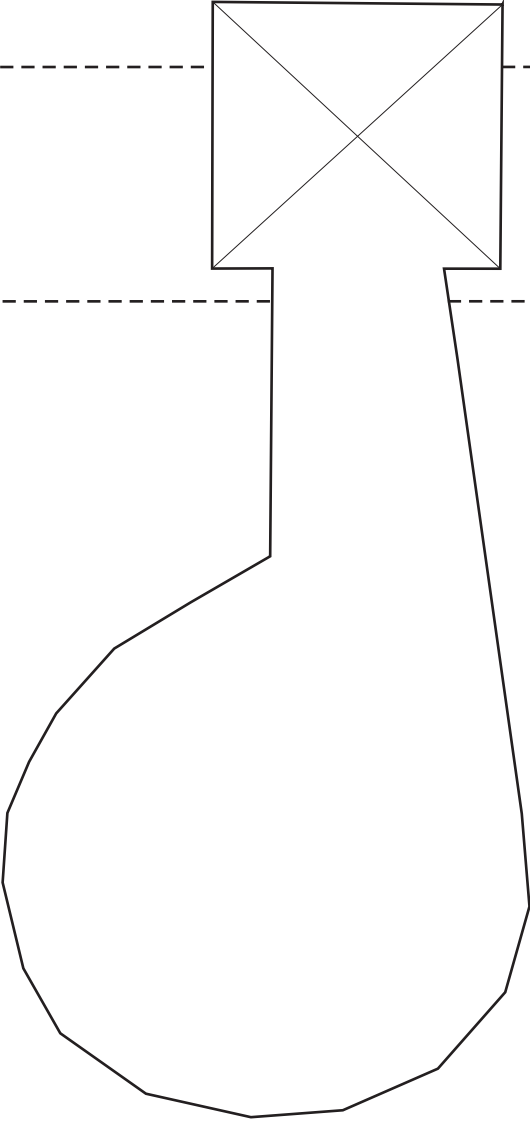

JOIN HERE

JOIN HERE

JOIN HERE

JOIN HERE

W1

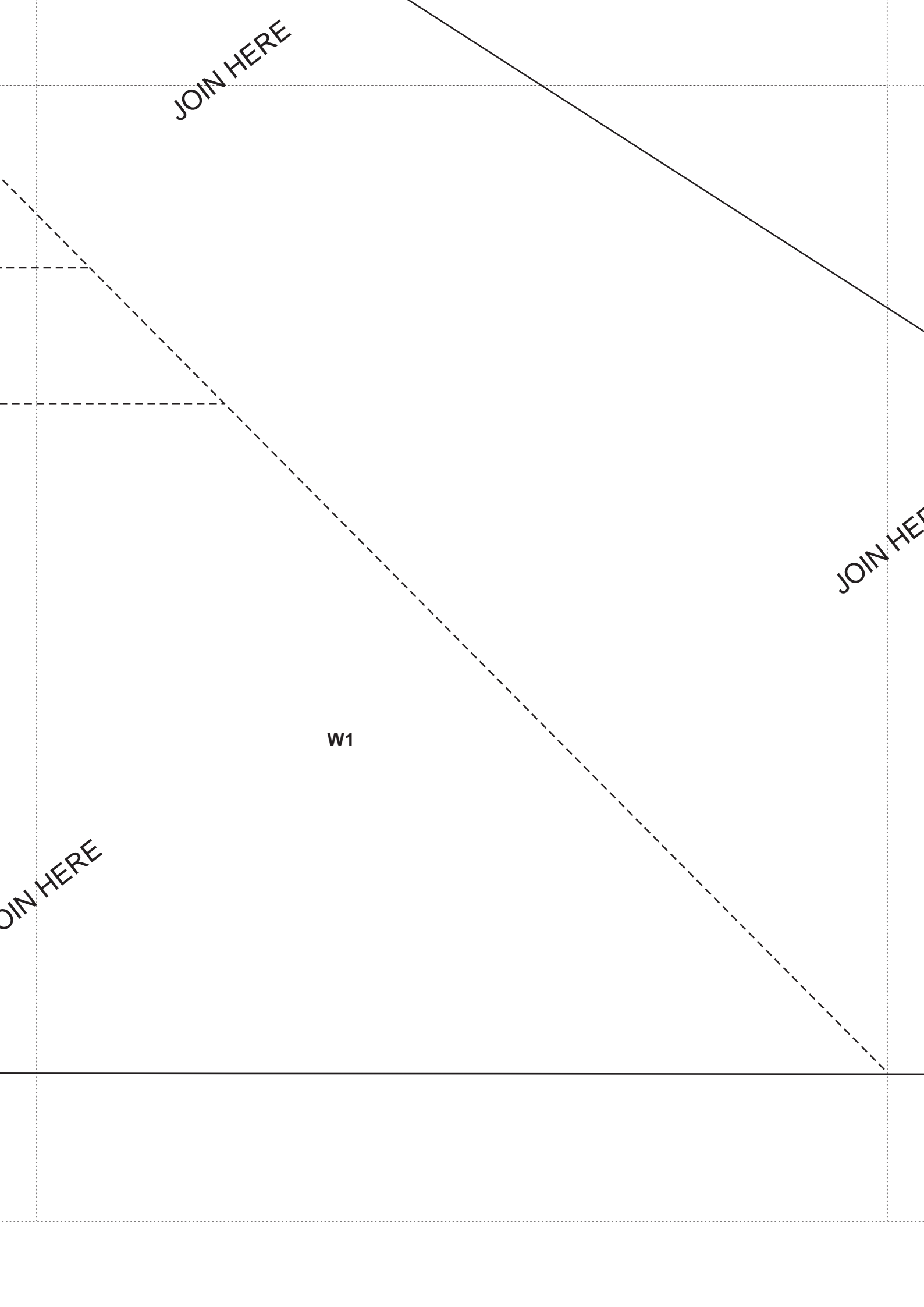

JOIN HERE

W1

JOIN HERE

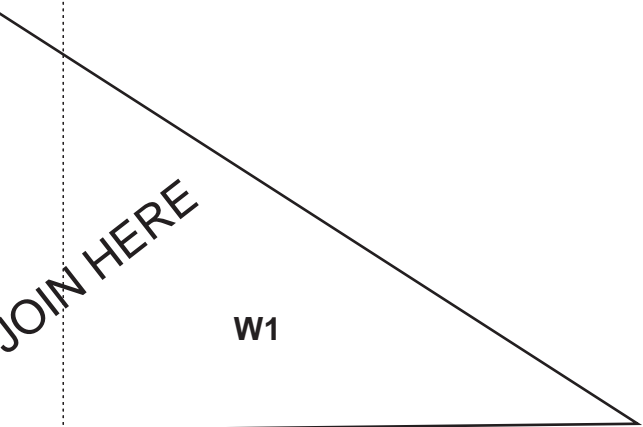

W3

WING SPAR
POLYFOAM/
DEPRON 5MM
2X MIRRORED

W4

WING SPAR
POLYFOAM/
DEPRON 5MM
2X MIRRORED

W5

WING SPAR
POLYFOAM/
DEPRON 5MM
2X MIRRORED

JOIN HERE

JOIN HERE

JOIN HERE

JOIN HERE

W3

JOIN HERE

JOIN HERE

W4

W5

JOIN HERE

JOIN HERE

W3

G2

LG PLATFORM
PLYWOOD 3MM
2X MIRRORED

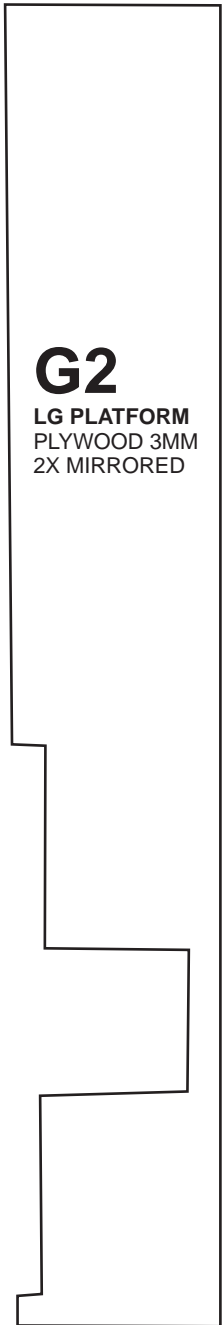

G3

LG PLATFORM
PLYWOOD 3MM
2X MIRRORED

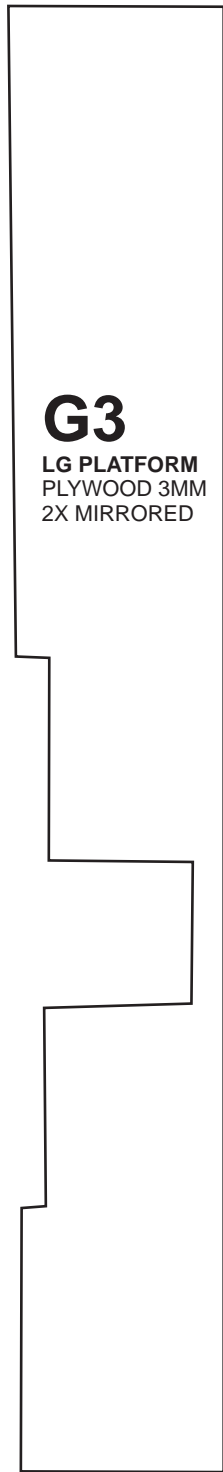

G1

LG PLATFORM
PLYWOOD 3MM
2X MIRRORED

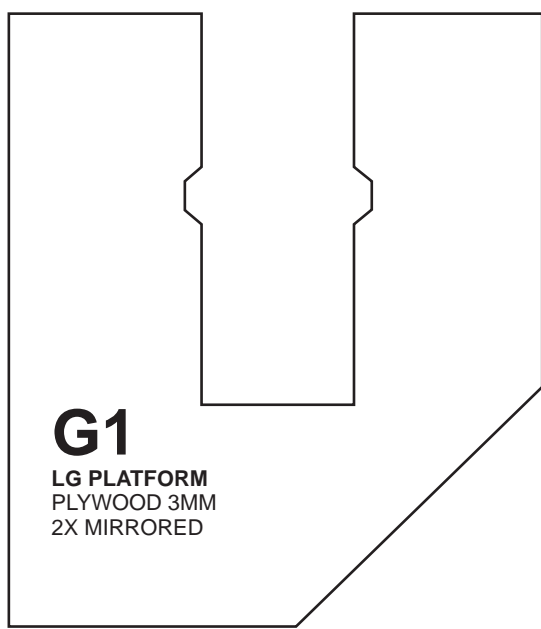

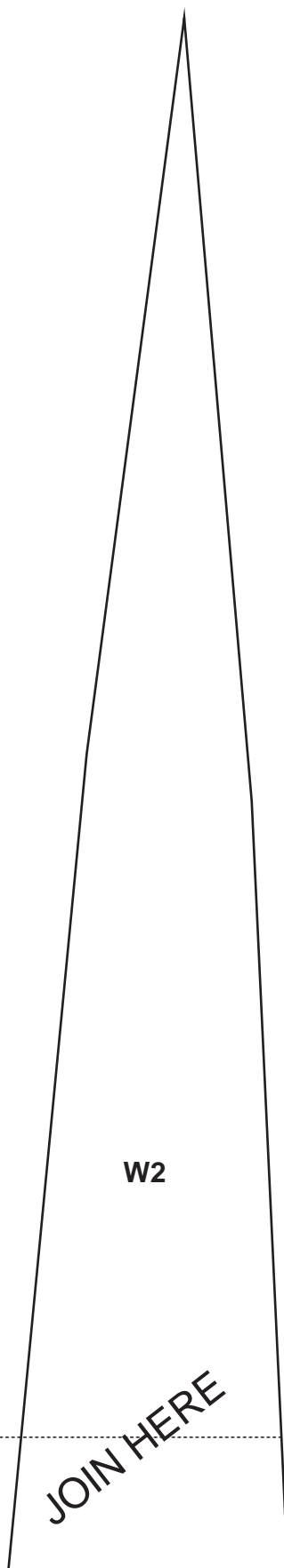

W2

JOIN HERE

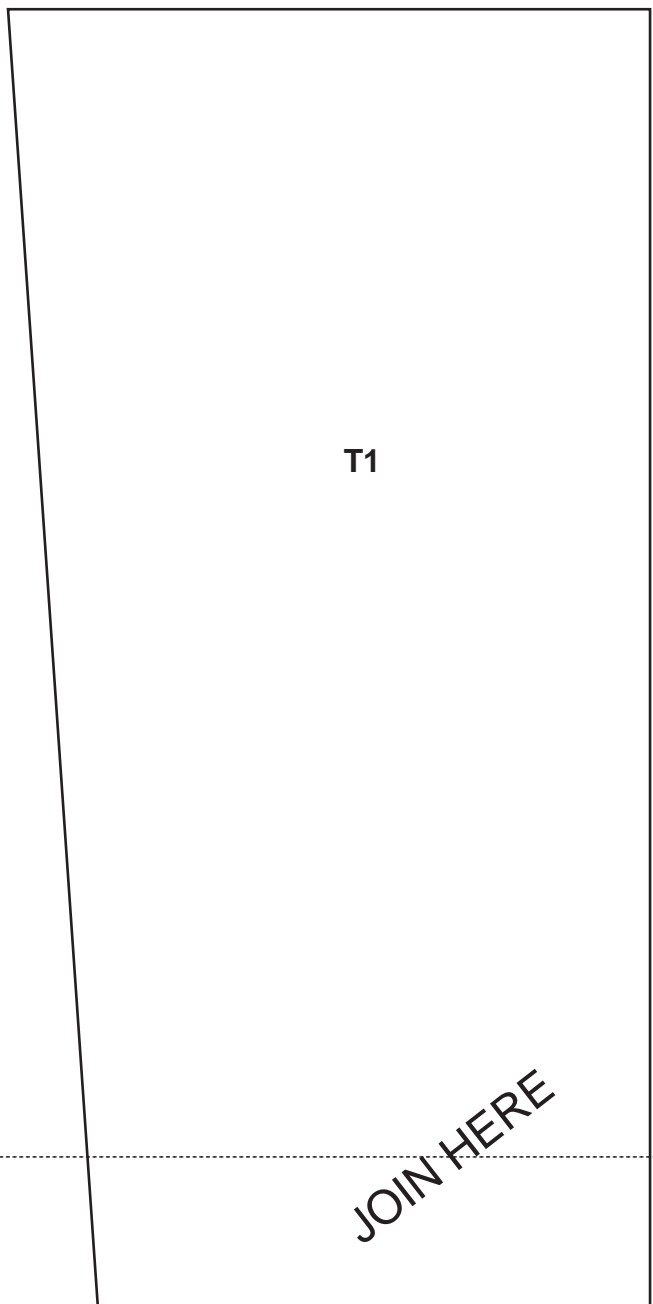

T1

JOIN HERE

JOIN HERE

W2

WING FORMER
POLYFOAM/
DEPRON 5MM
2X MIRRORED

JOIN HERE

JOIN HERE

W2

JOIN HERE

JOIN HERE

W2

W6

JOIN HER

JOIN HERE

W6

JOIN HERE

JOIN HERE

W6

WING
POLYFOAM/ DEPRON 3MM
2X MIRRORED

JOIN HERE

JOIN HERE

JOIN HERE

W6

JOIN HERE

JOIN HERE

JOIN HERE

W6

JOIN HERE

JOIN HERE

W6

JOIN HERE

JOIN HERE

JOIN HERE

W6

JOIN HER

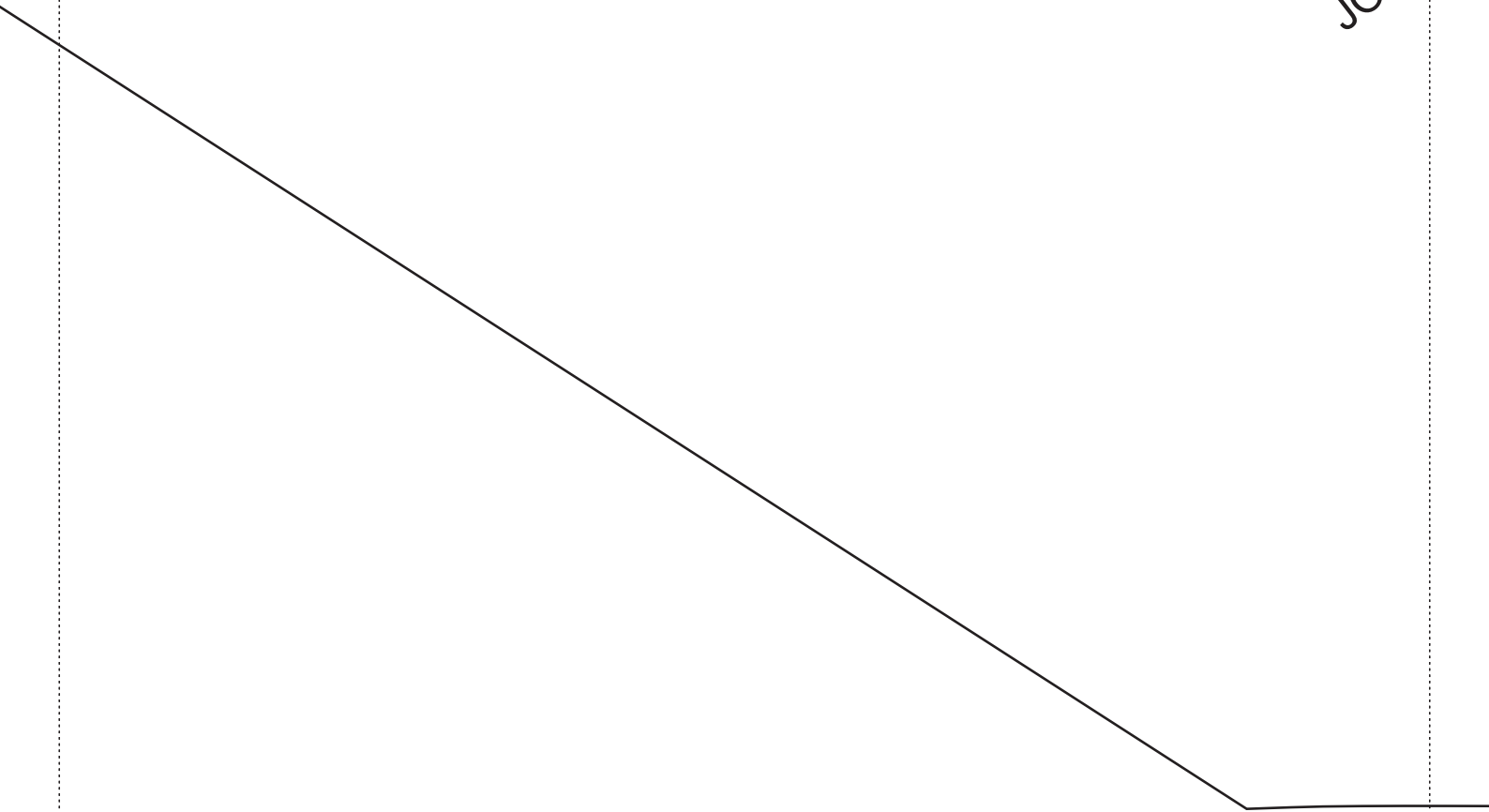

JOIN HERE

W6

JOIN HERE

F9
FUSELAGE
POLYFOAM/ DEPRON 3MM

JOIN HERE

FRONT 

JOIN HERE

F9

JOIN HERE

JOIN HERE

F9

F10

FUSELAGE FORMER
POLYFOAM/ DEPRON 5MM

SEAM



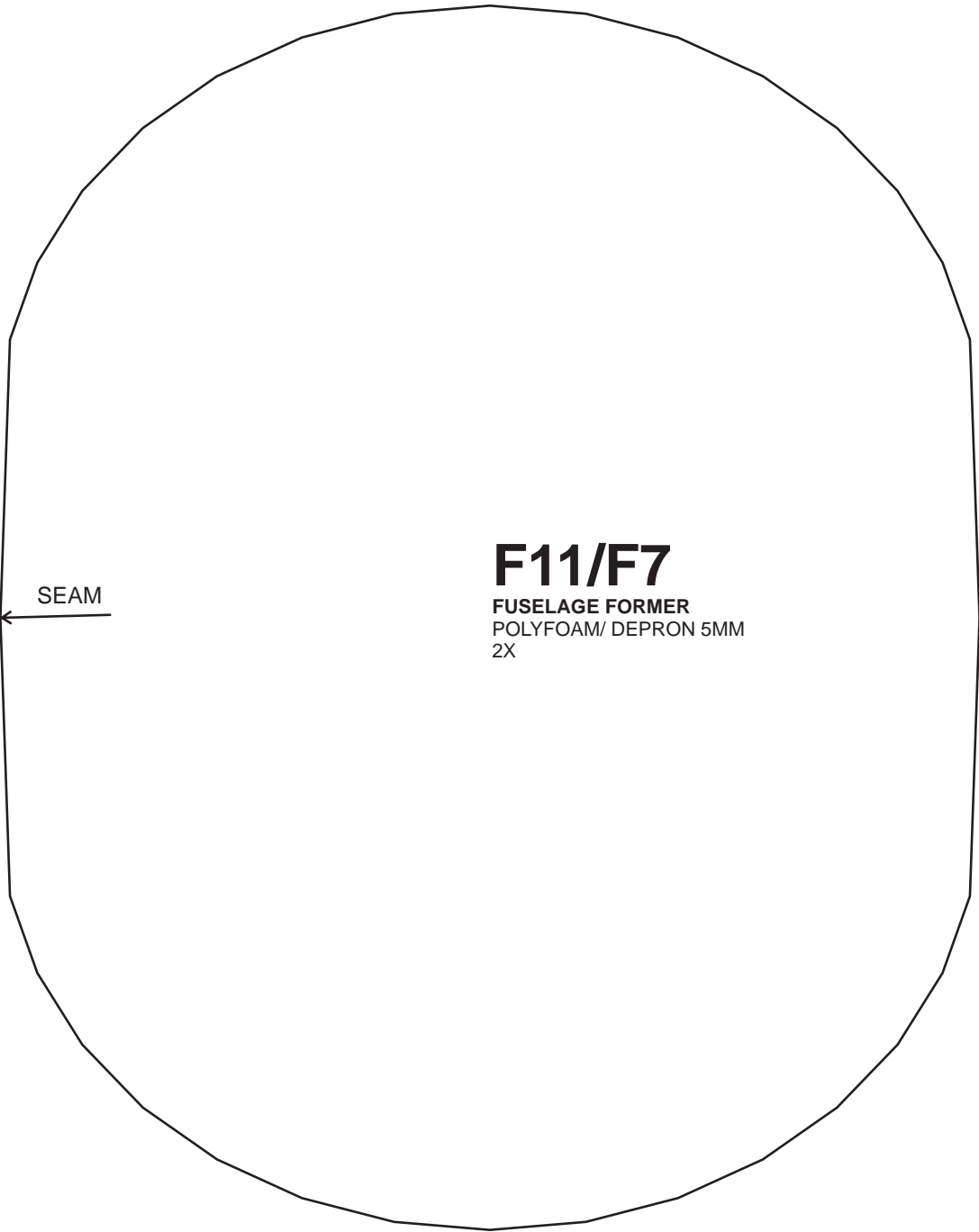

← SEAM

F11/F7
FUSELAGE FORMER
POLYFOAM/ DEPRON 5MM
2X

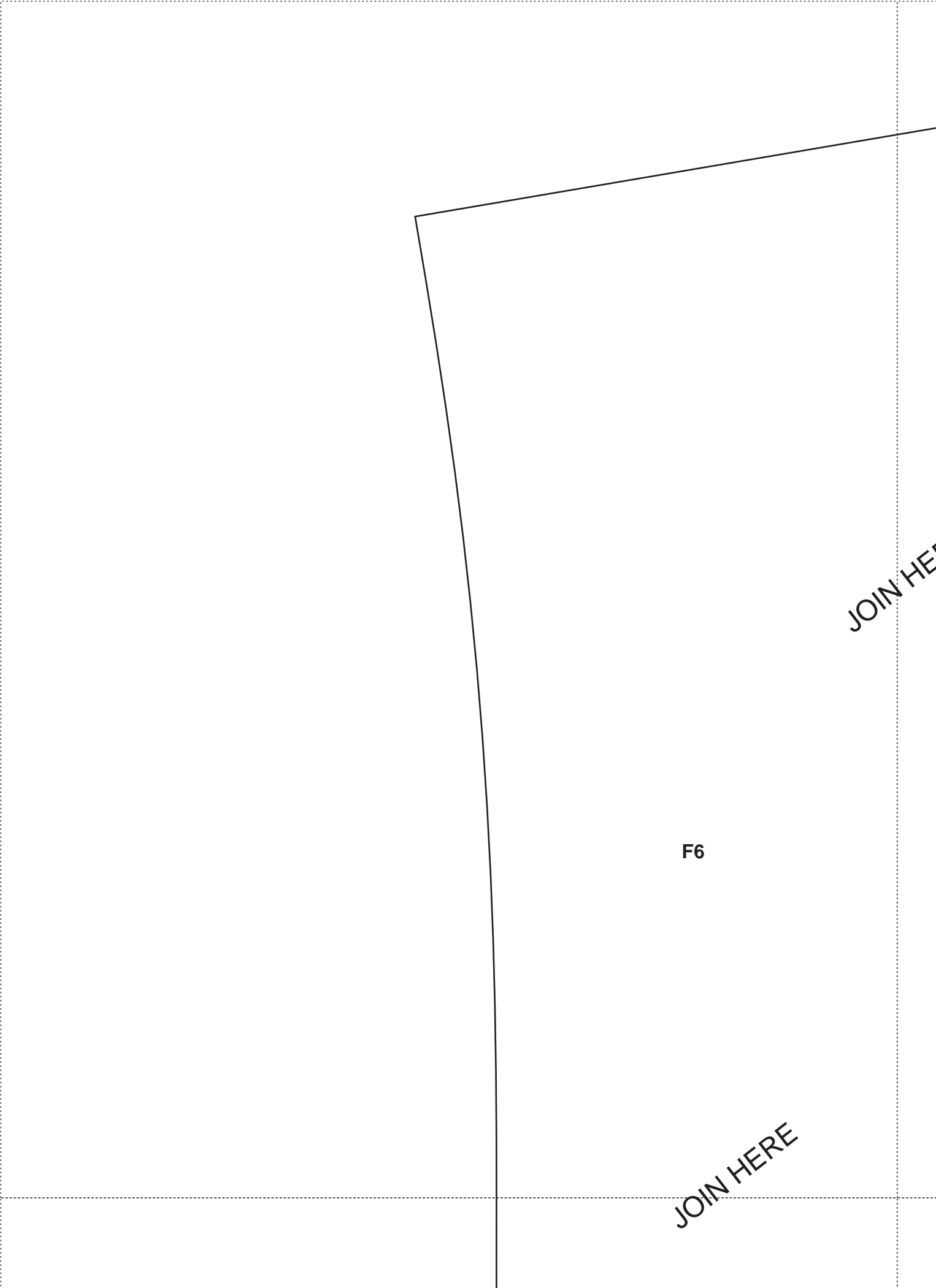

F6

JOIN HERE

JOIN HERE

JOIN HERE

F6

FUSELAGE
POLYFOAM/ DEPRON 3MM

JOIN HERE

FRONT 

JOIN HERE

F6

JOIN HERE

JOIN HERE

F6

JOIN HERE

JOIN HERE

JOIN HERE

F6

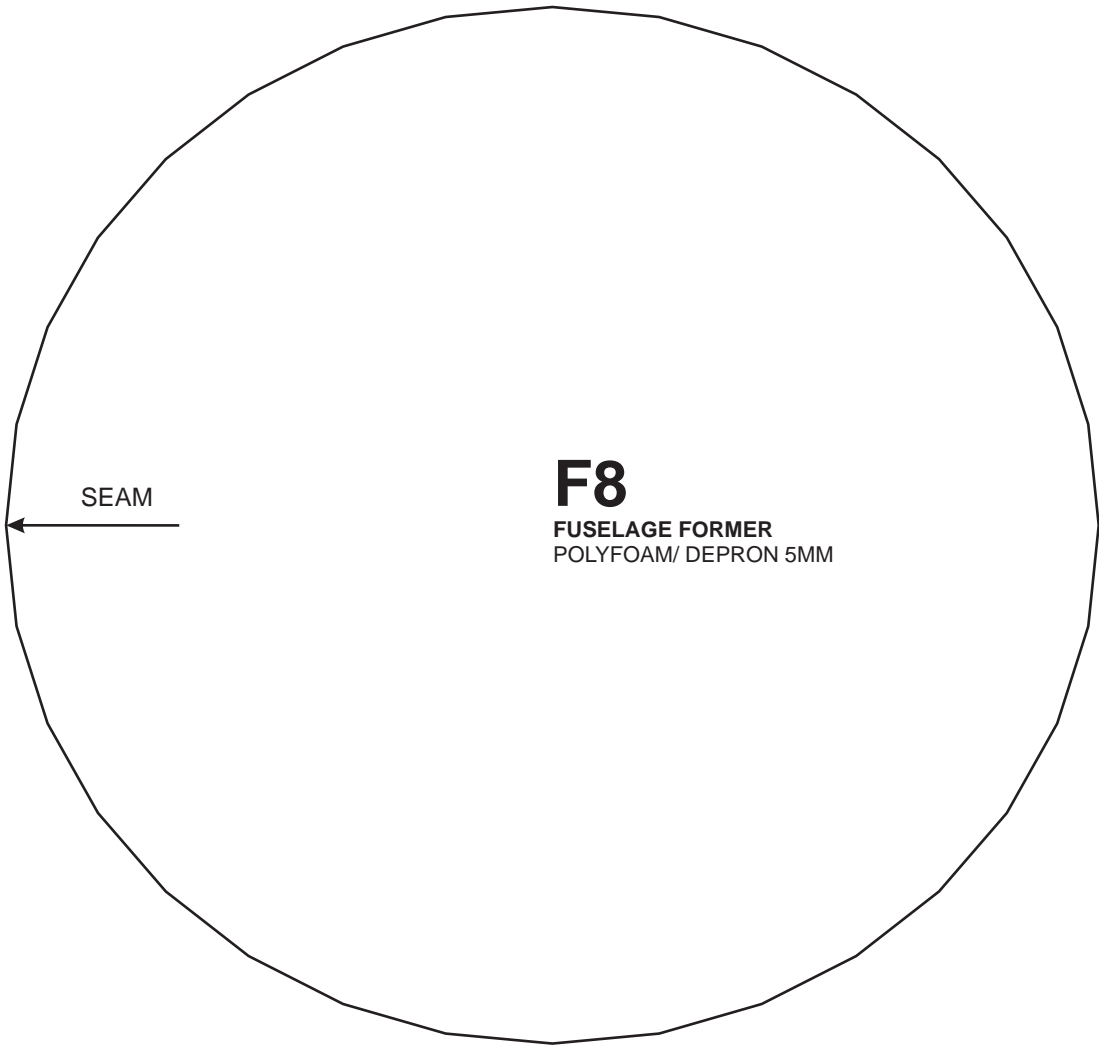

F8

FUSELAGE FORMER
POLYFOAM/ DEPRON 5MM

F12

FUSELAGE
POLYFOAM/ DEPRON 3MM

← FRONT

JOIN HERE

JOIN HERE

F12

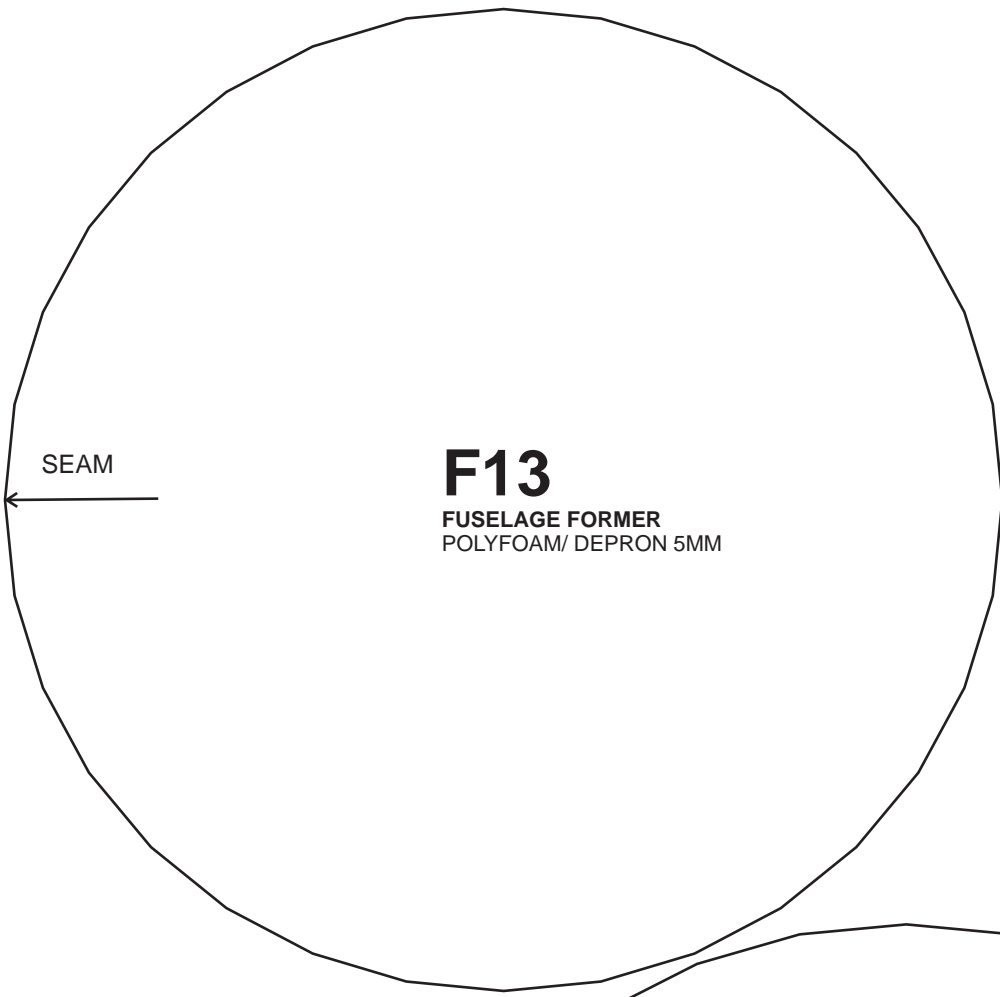

F13
FUSELAGE FORMER
POLYFOAM/ DEPRON 5MM

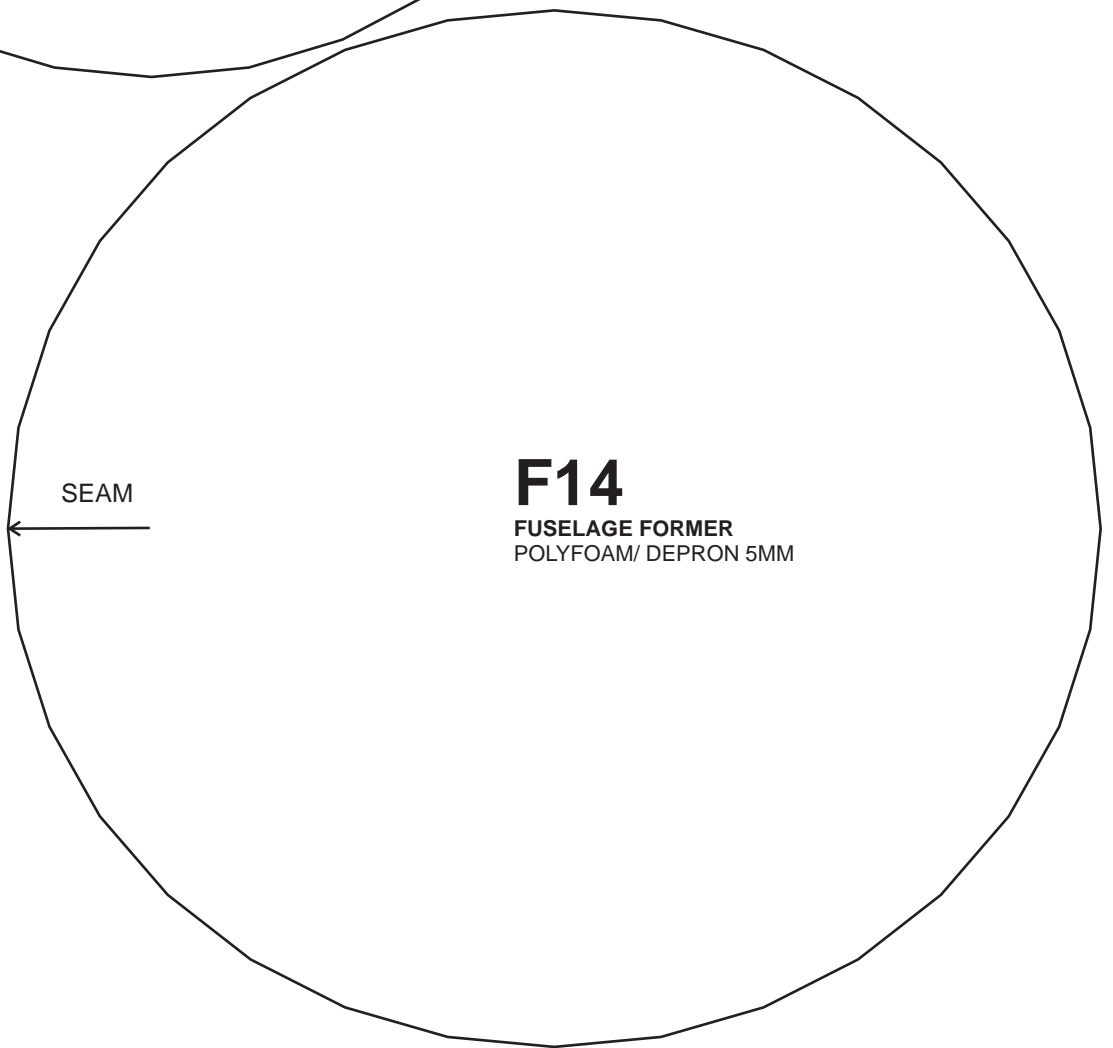

F14
FUSELAGE FORMER
POLYFOAM/ DEPRON 5MM

F15

FUSELAGE
POLYFOAM/ DEPRON 3MM

← FRONT

JOIN HERE

JOIN HERE

F15

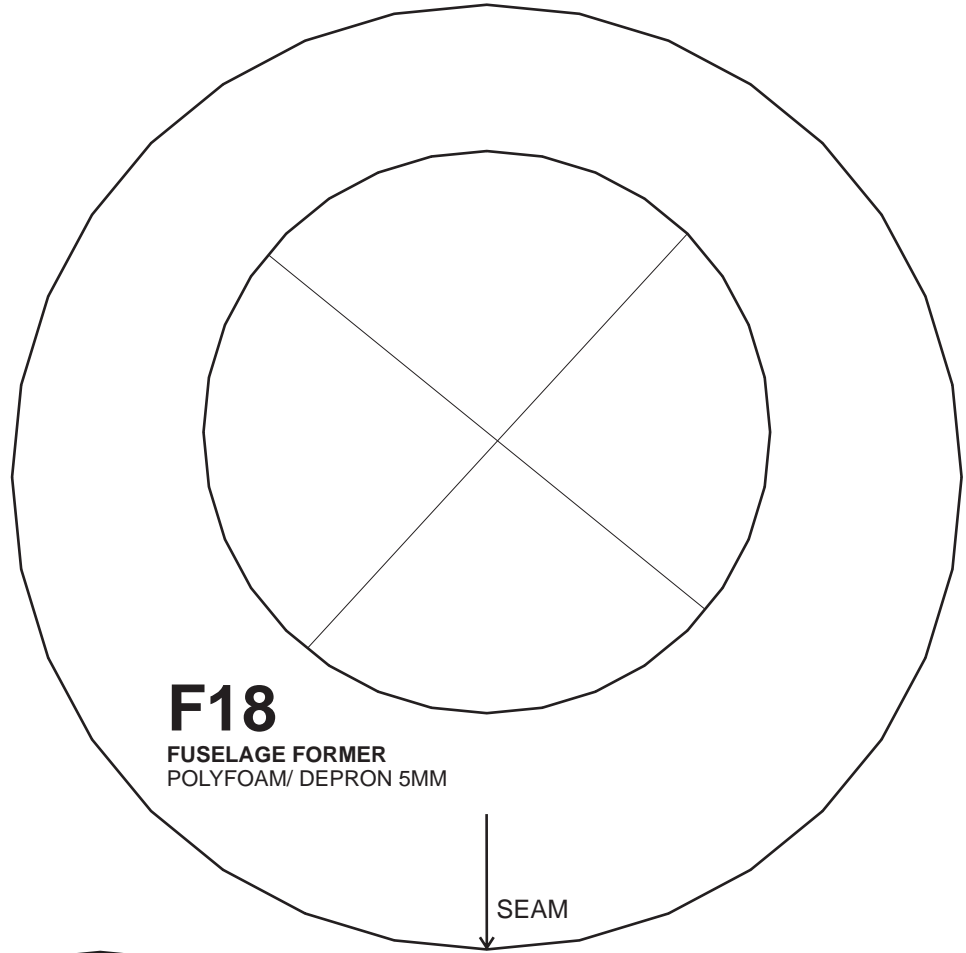

F18

FUSELAGE FORMER
POLYFOAM/ DEPRON 5MM

SEAM

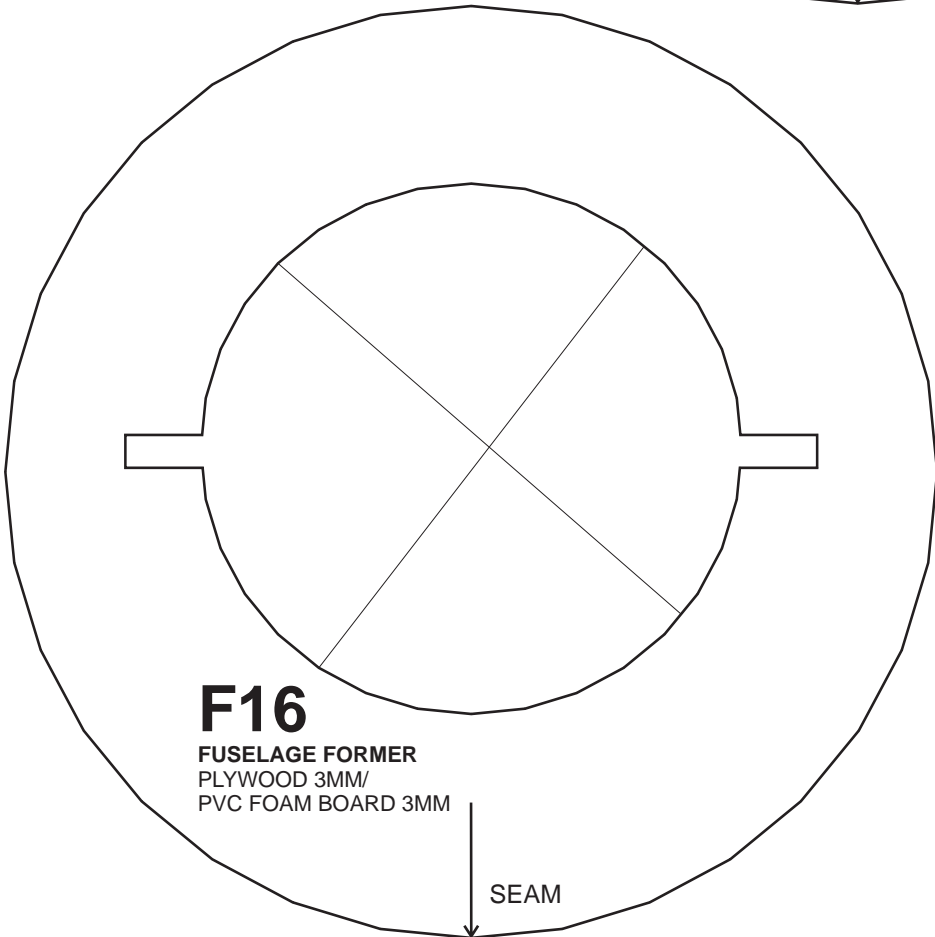

F16

FUSELAGE FORMER
PLYWOOD 3MM/
PVC FOAM BOARD 3MM

SEAM

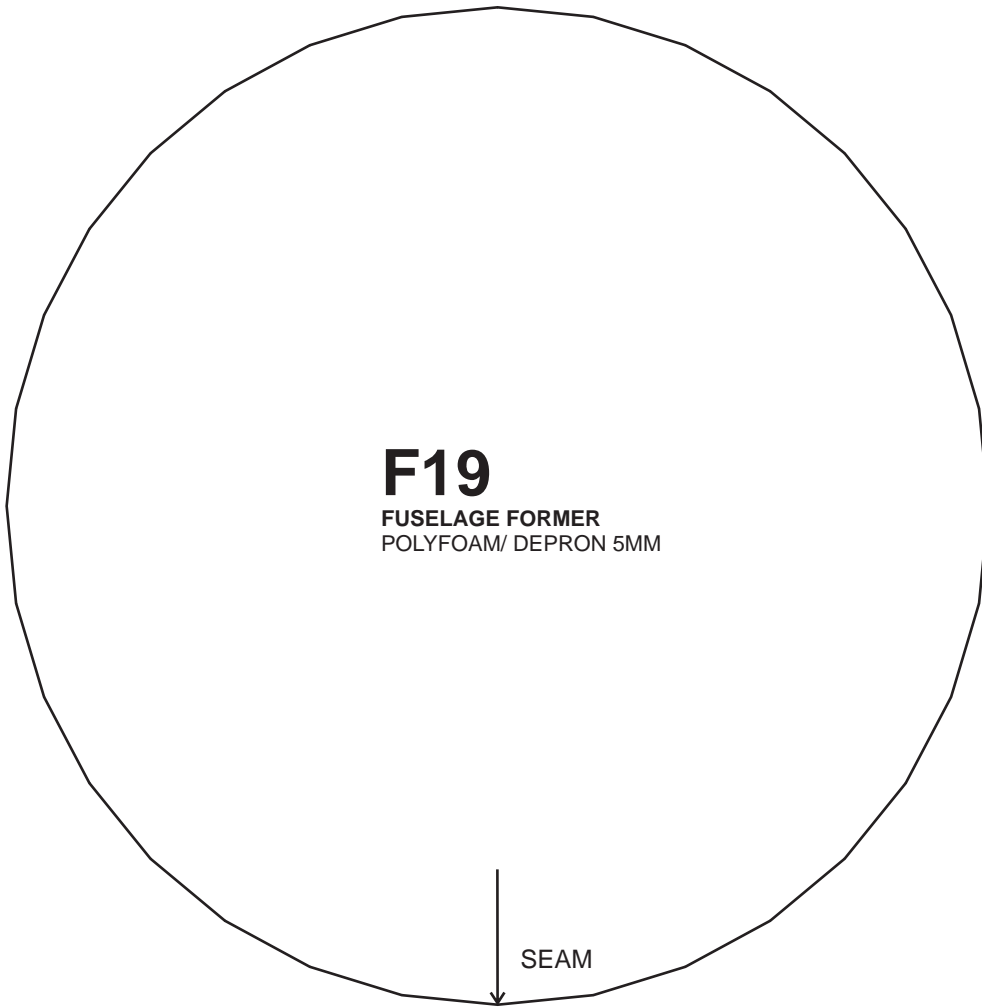

F19

FUSELAGE FORMER
POLYFOAM/ DEPRON 5MM

SEAM



F17

FUSELAGE
POLYFOAM/ DEPRON 3MM

FRONT 



F20

FUSELAGE
POLYFOAM/ DEPRON 3MM

FRONT 

JOIN HERE

JOIN HERE

F20

F22

AIR INTAKE FORMER
POLYFOAM/ DEPRON 5MM
2X MIRRORED

F21

AIR INTAKE
POLYFOAM/ DEPRON 3MM
2X MIRRORED

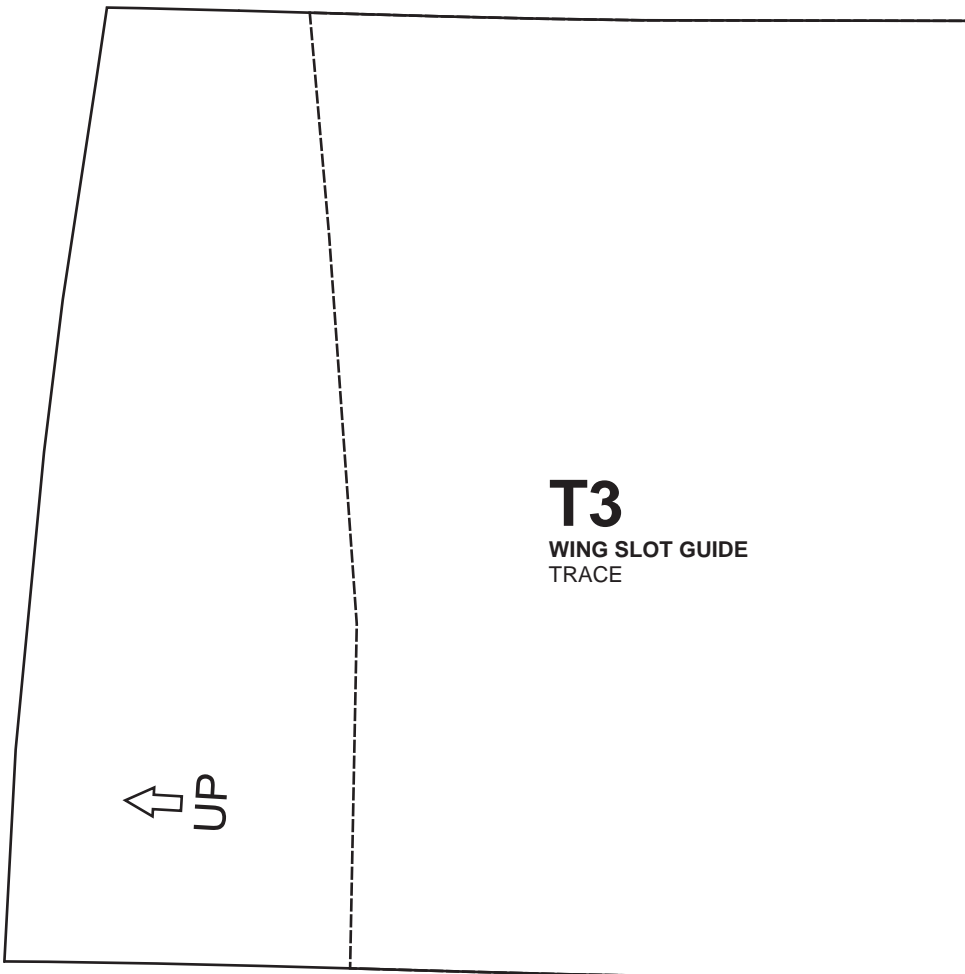
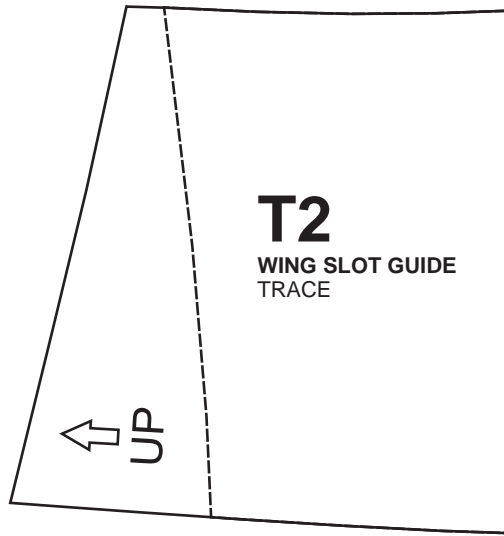



T4

WING SLOT GUIDE
TRACE

↑
UP

JOIN HERE

JOIN HERE

T4

T5

WING SLOT GUIDE
TRACE

↑
UP

T6

WING SLOT GUIDE
TRACE

↑
UP

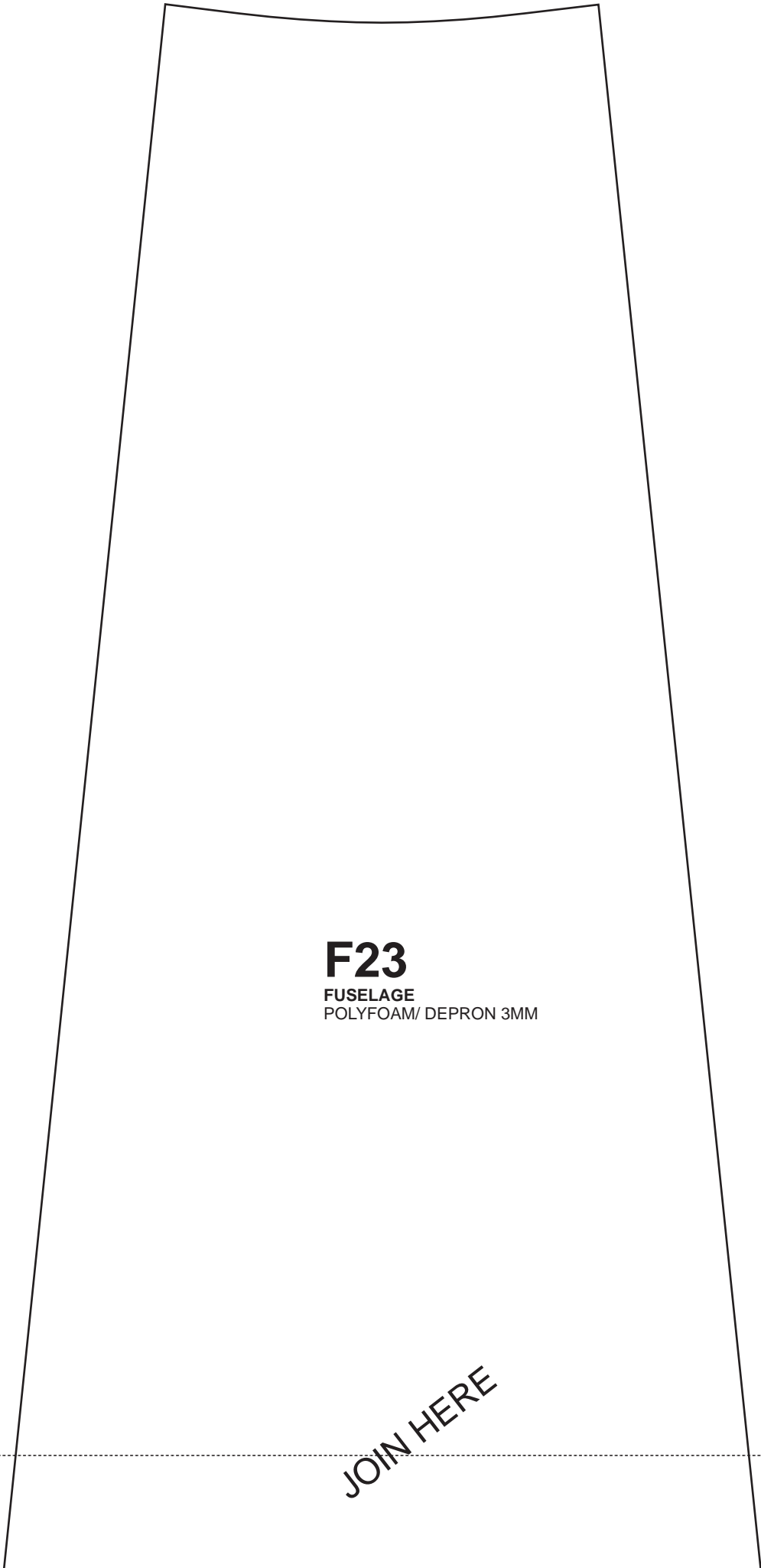

F23

FUSELAGE
POLYFOAM/ DEPRON 3MM

JOIN HERE

JOIN HERE

F23

F24

FUSELAGE
POLYFOAM/ DEPRON 5MM

F25

FUSELAGE
POLYFOAM/
DEPRON 5MM

F26
FUSELAGE
POLYFOAM/ DEPRON 3MM

JOIN HERE

JOIN HERE

F26

JOIN HERE

S1

JOIN HERE

HEP

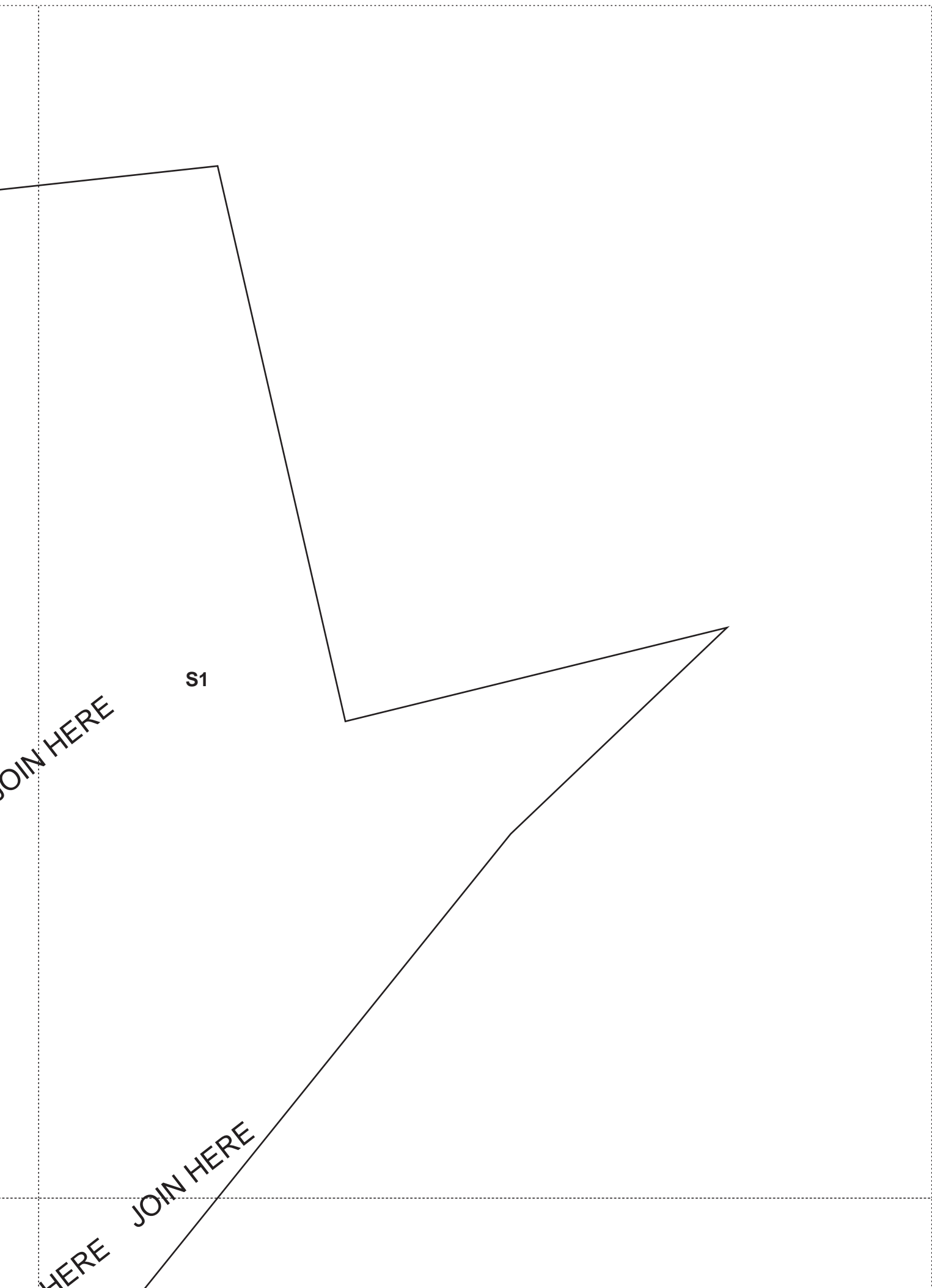

S1

JOIN HERE

JOIN HERE

HERE

JOIN HERE

JOIN HERE

S1

VERTICAL STABILIZER
POLYFOAM/ DEPRON 5MM

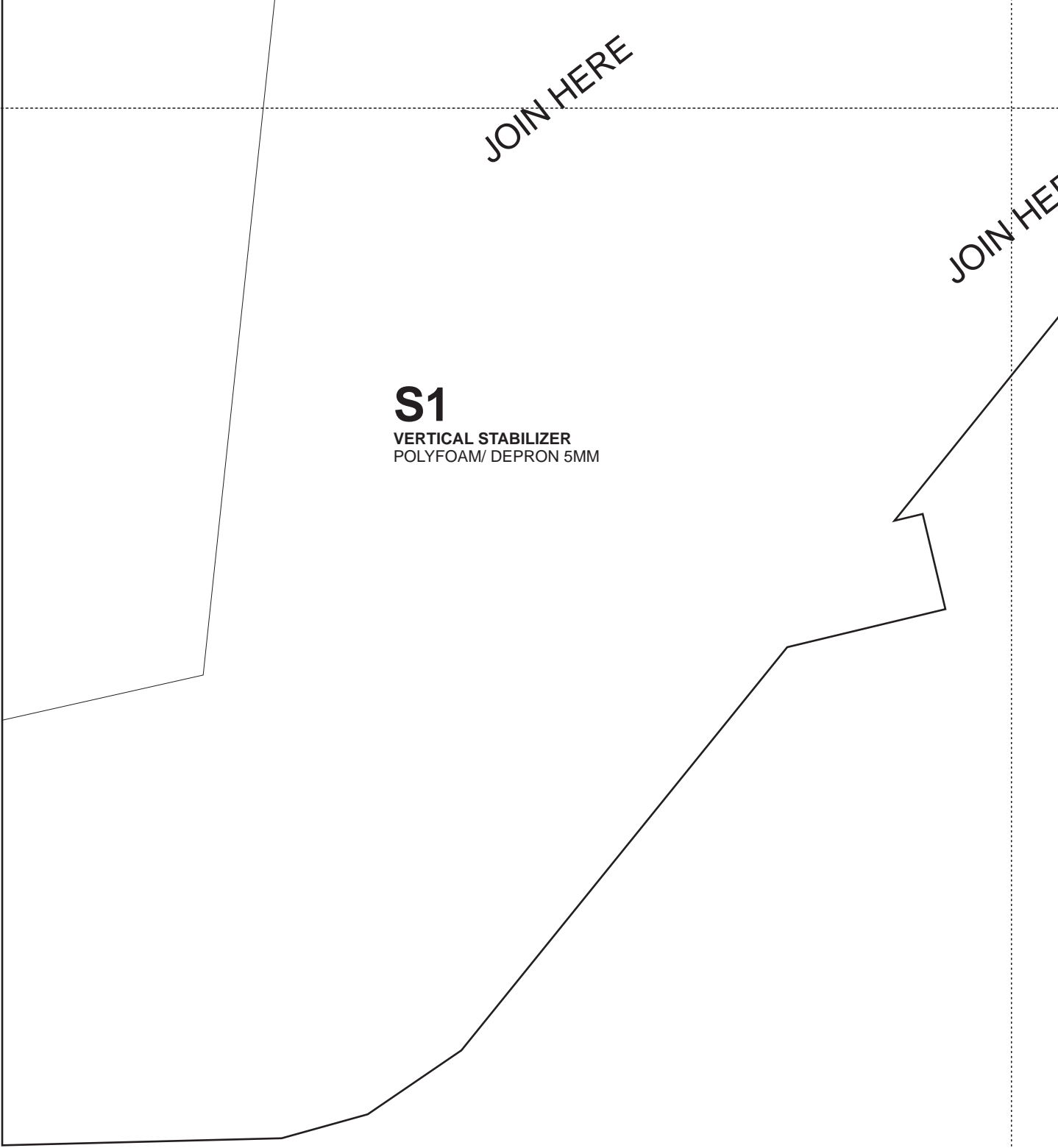

JOIN HERE
S1
JOIN HERE

MIRROR HERE 

N3
NOSE SECTION
POLYFOAM/ DEPRON 3MM
2X MIRRORED

JOIN HERE

JOIN HERE

N3

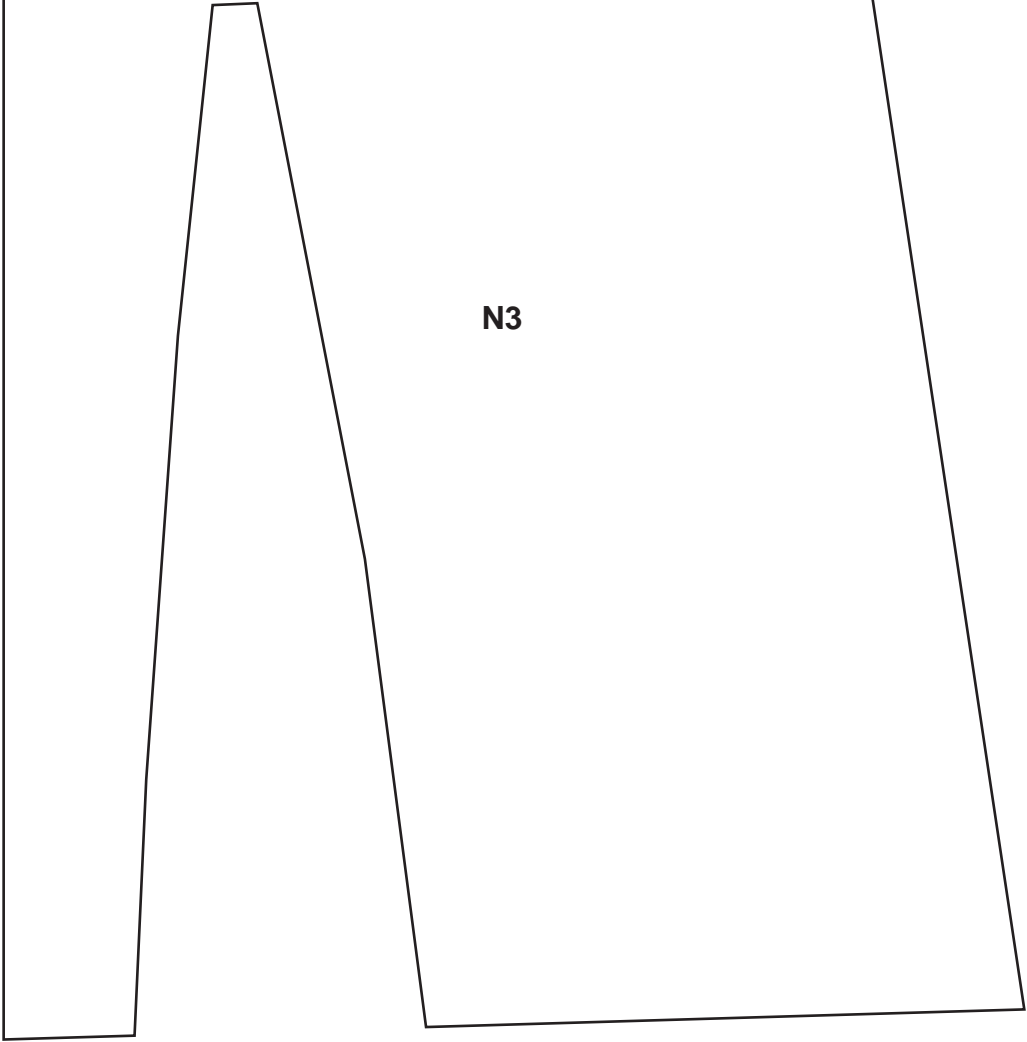

N1

NOSE SECTION
POLYFOAM/ DEPRON 3MM

N4

NOSE SECTION FORMER
POLYFOAM/ DEPRON 5MM

JOIN HERE

JOIN HERE

N1

N2

NOSE SECTION FORMER
POLYFOAM/ DEPRON 5MM

SEAM





N5

NOSE SECTION
POLYFOAM/ DEPRON 3MM

N6

NOSE SECTION
POLYFOAM/ DEPRON 3MM

JOIN HERE

JOIN HERE

N5

N7

NOSE SECTION
POLYFOAM/ DEPRON 3MM

N8

NOSE SECTION
PAPER CARD
150 gram

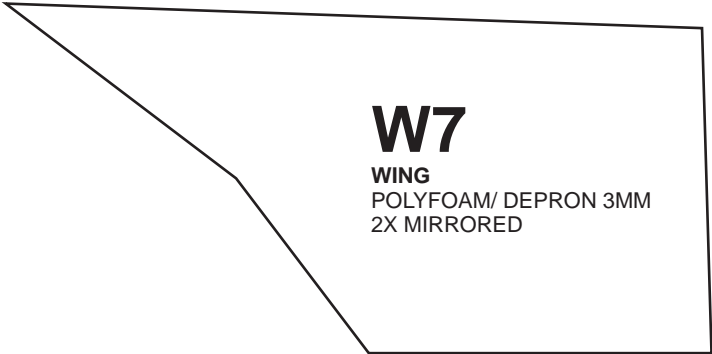



JOIN HERE

JOIN HERE

W8

W8

W8
WING FAIRING
PAPER CARD
150 GSM

JOIN HERE

JOIN HERE

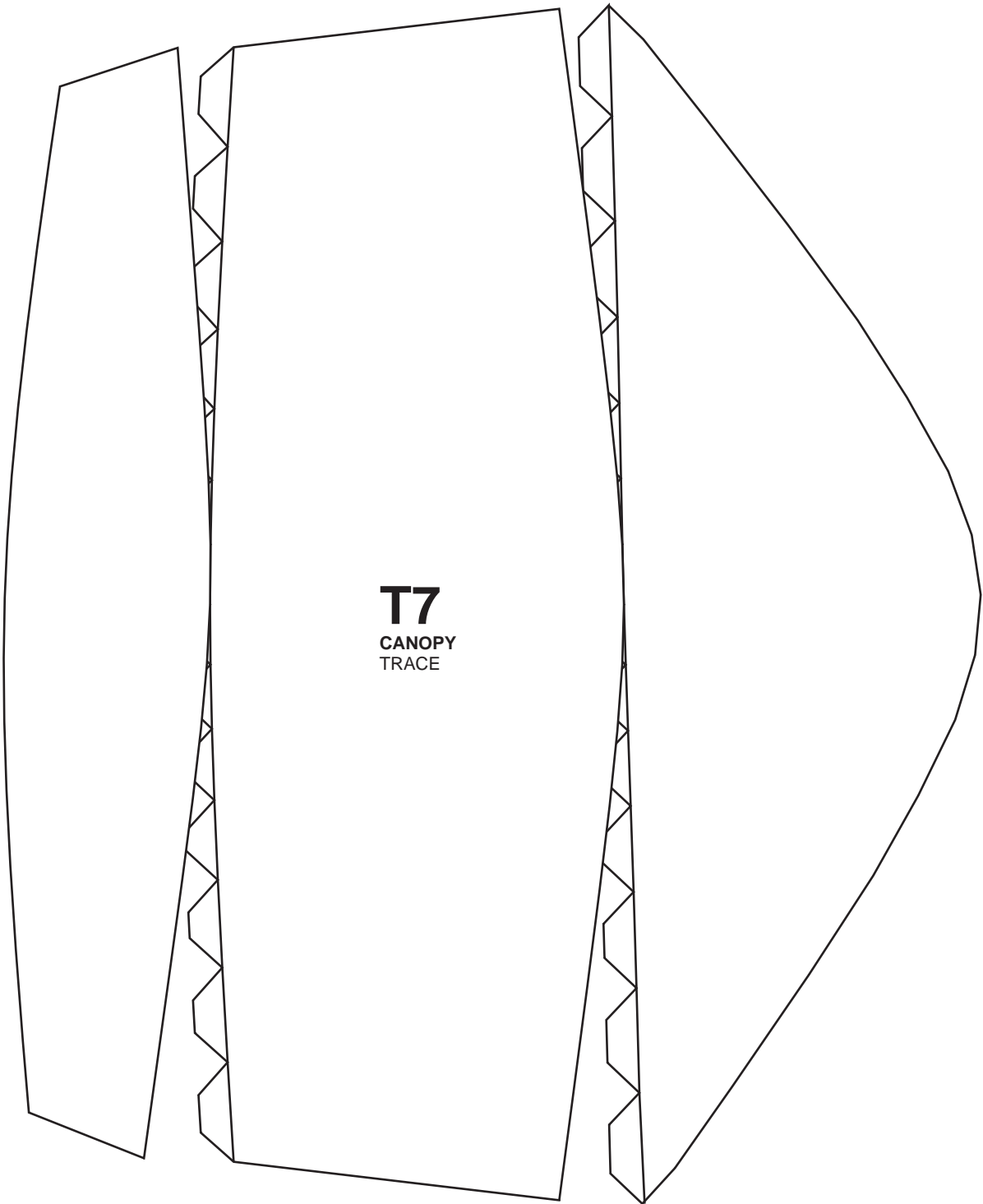

T7
CANOPY
TRACE

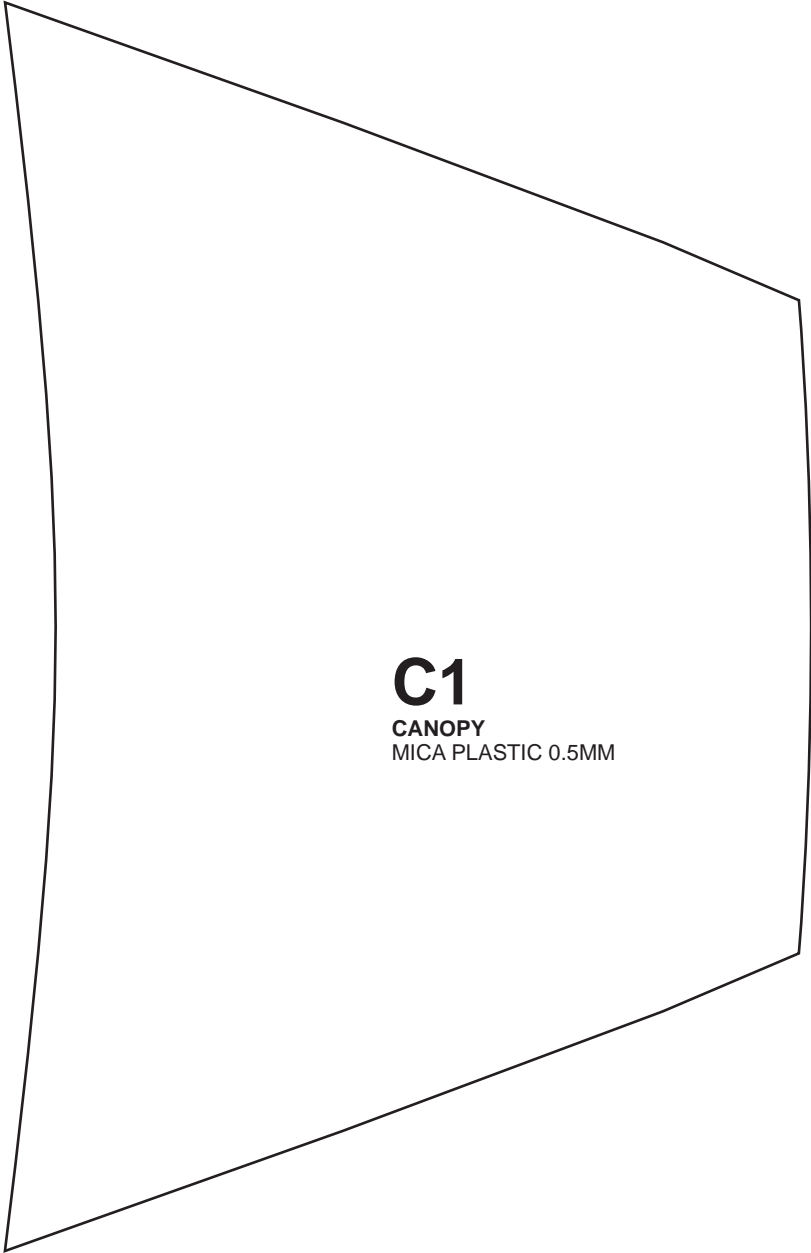

C1
CANOPY
MICA PLASTIC 0.5MM

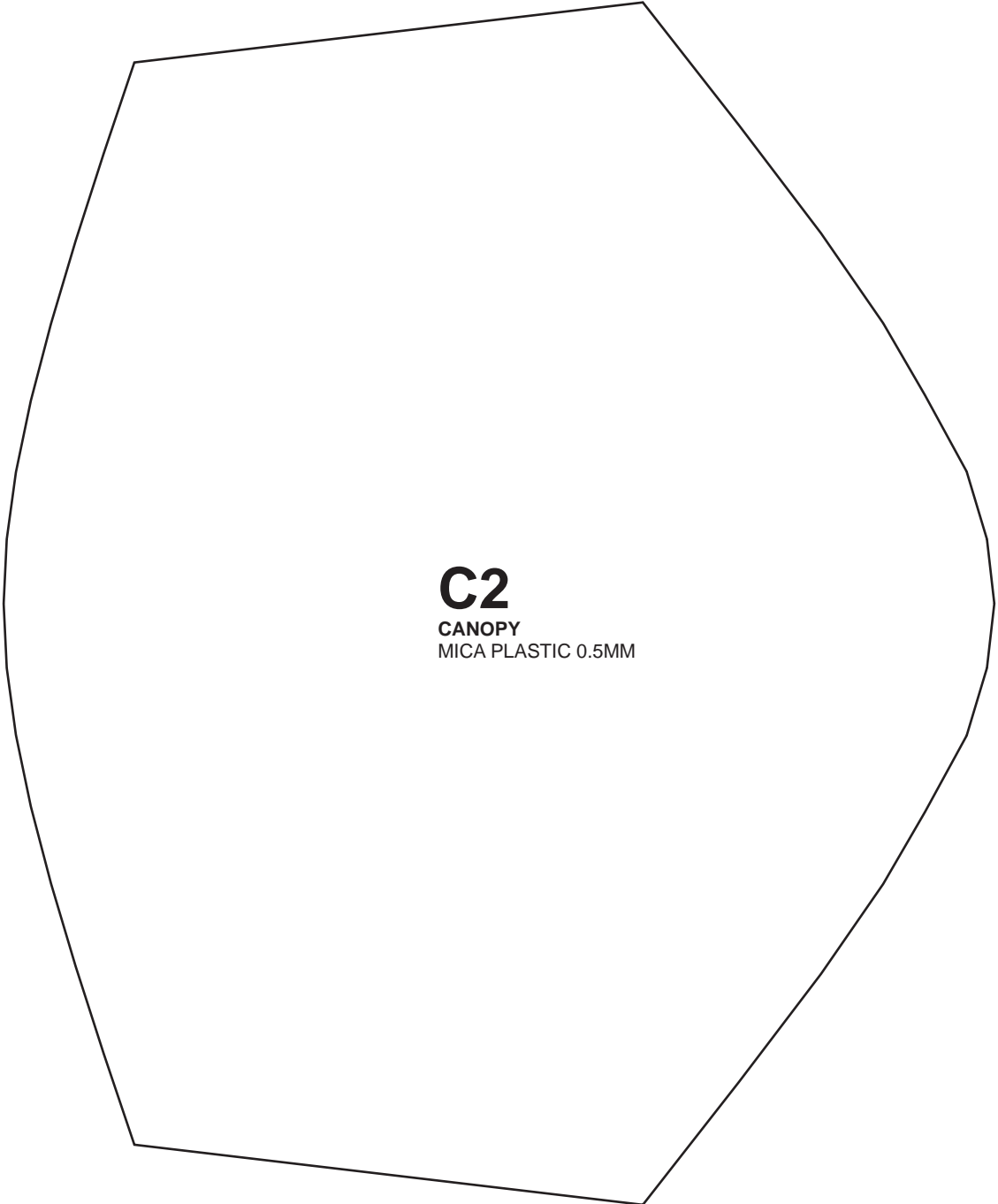

C2

CANOPY
MICA PLASTIC 0.5MM

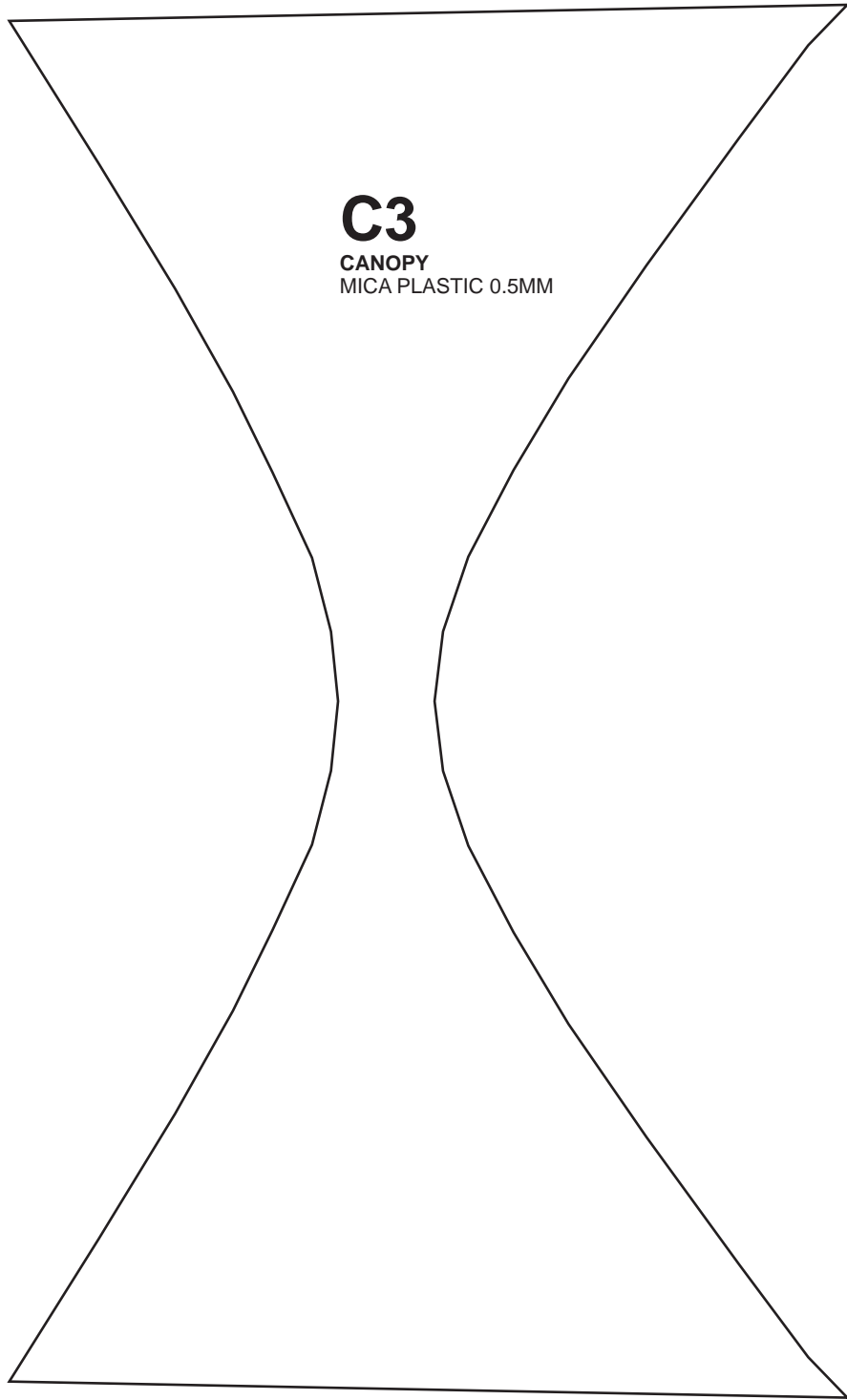

C3

CANOPY
MICA PLASTIC 0.5MM

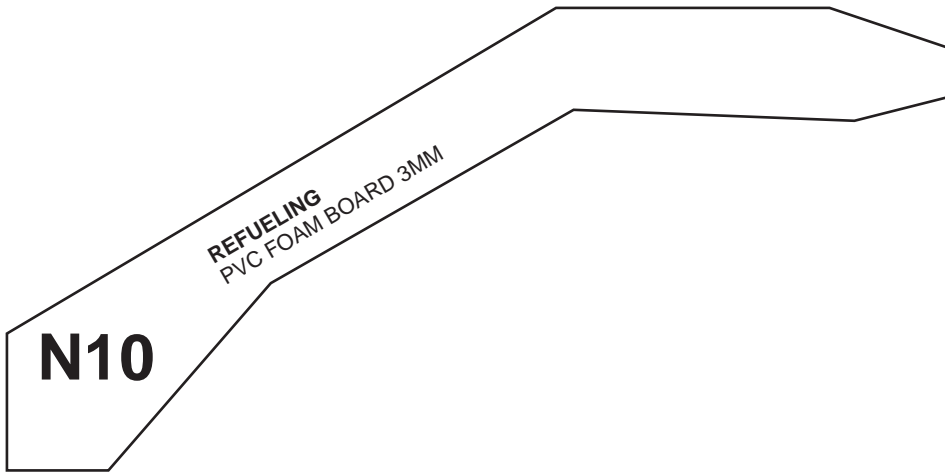
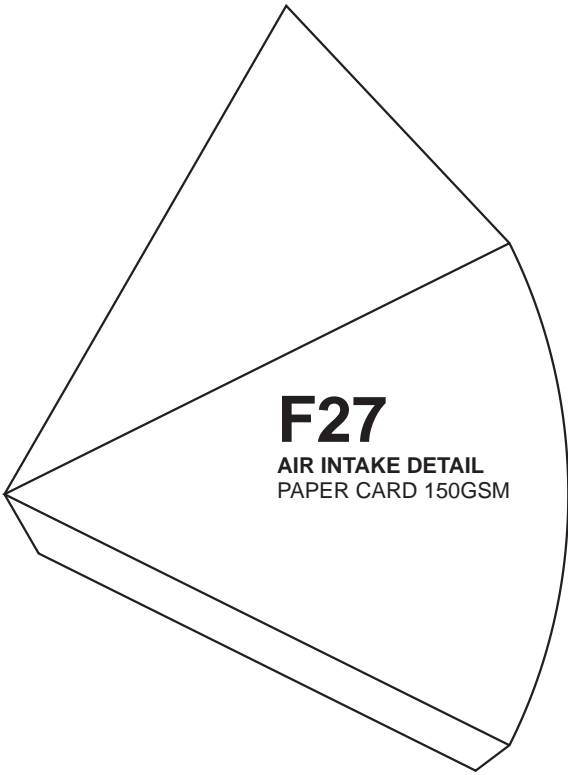

DROP TANK

JOIN HERE

DROP TANK
2X

JOIN HERE

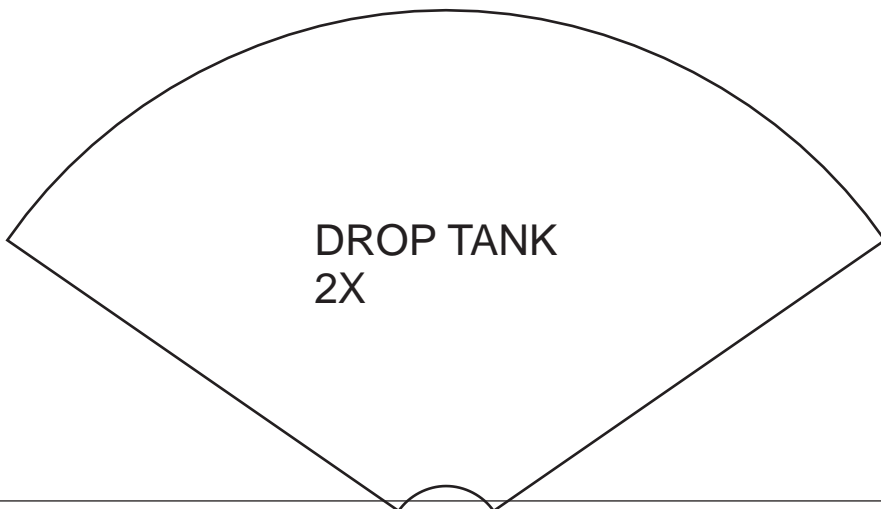

DROP TANK
2X