



Model : 09/2020



# BOEING 737-300

## 1800mm - COMPLETE

### Specs :

1. Wingspan 1800mm / 71 inches
2. Flying weight : 2300 grams/ 82.9 oz
3. Wing loading : 53.4 g/dm<sup>2</sup> - 17.5 oz/sq.ft
4. Wing cube loading : 8
5. Wing Area : 44 dm<sup>2</sup> / 682 sq.in
6. CG : 17 cm from TE
7. 1 set of Servoless Retractable Landing Gear for 3 kg

### Electronics

- 2X NTM 2830 1000kv brushless motor
- 2X ZTW ESC 40A
- Battery Lipo 3S 2200mah - 3S 5200mah - Li
- 4 plastic gear 9 gram servos
- 2 metal gear 9 gram servos
- Propeller : 9x5x3 MA style props

### Materials :

1. 5mm & 10mm Depron/ Polyfoam
2. 3mm Plywood
4. 0.3mm Mica Plastic
5. hot glue + CA glue + UHU glue
6. white packing tape



### Build Instructions :

1. [paper-replika.com](http://paper-replika.com)
2. youtube channel : Julius Perdana

**F1**

FUSELAGE  
POLYFOAM/ DEPRON 5MM

JOIN HERE

JOIN HERE

JOIN HERE

F1

JOIN HERE

JOIN HERE

JOIN HERE

JOIN HERE

F1

JOIN HERE

HERE

JOIN HERE

**F1**

**F3**

**FUSELAGE**  
POLYFOAM/ DEPRON 5MM

JOIN HERE

JOIN HERE

JOIN HERE

F1

JOIN HER

JOIN HERE

JOIN HERE

F1

JOIN HERE

JOIN HERE

JOIN HERE

JOIN HERE

F1

JOIN HERE

JOIN HERE

JOIN HERE



JOIN HERE

JOIN HERE

F1

F3

JOIN HERE

JOIN HERE

JOIN HERE

JOIN HERE

F1

JOIN HE

# LANDING GEAR DOOR MECHANISM

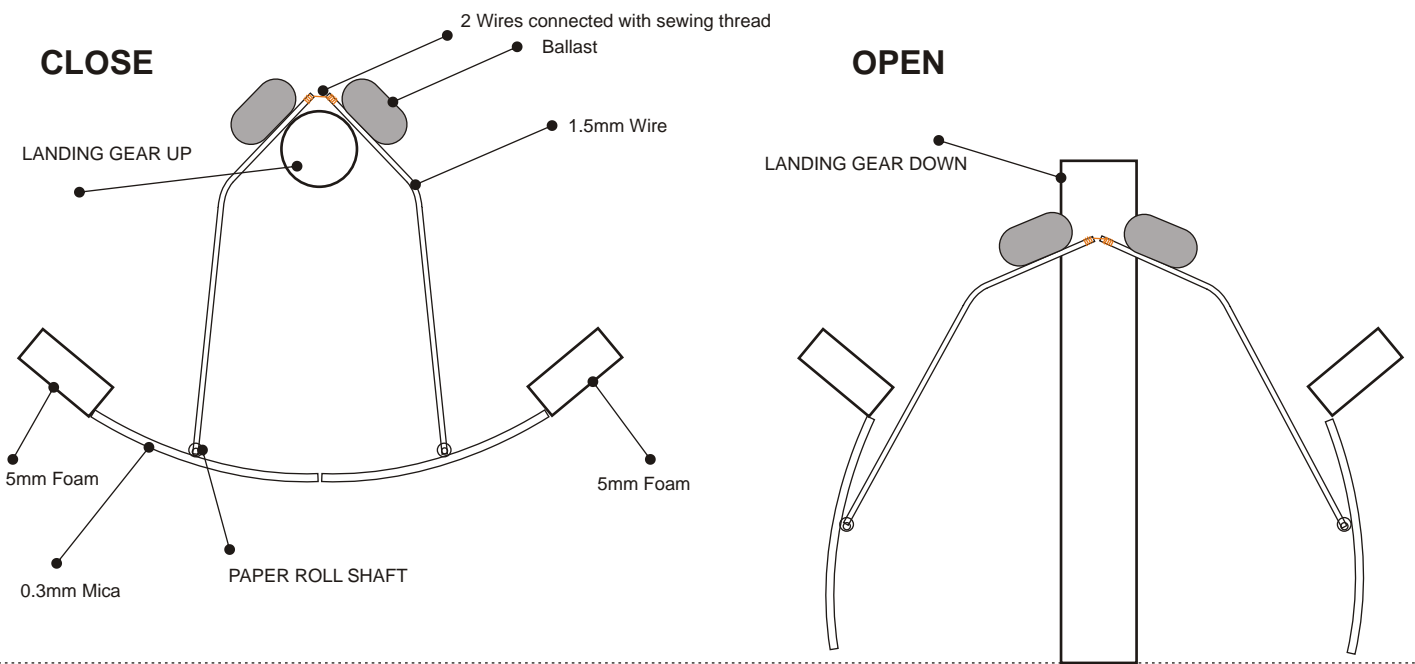

JOIN HERE

JOIN HERE

JOIN HERE

F1

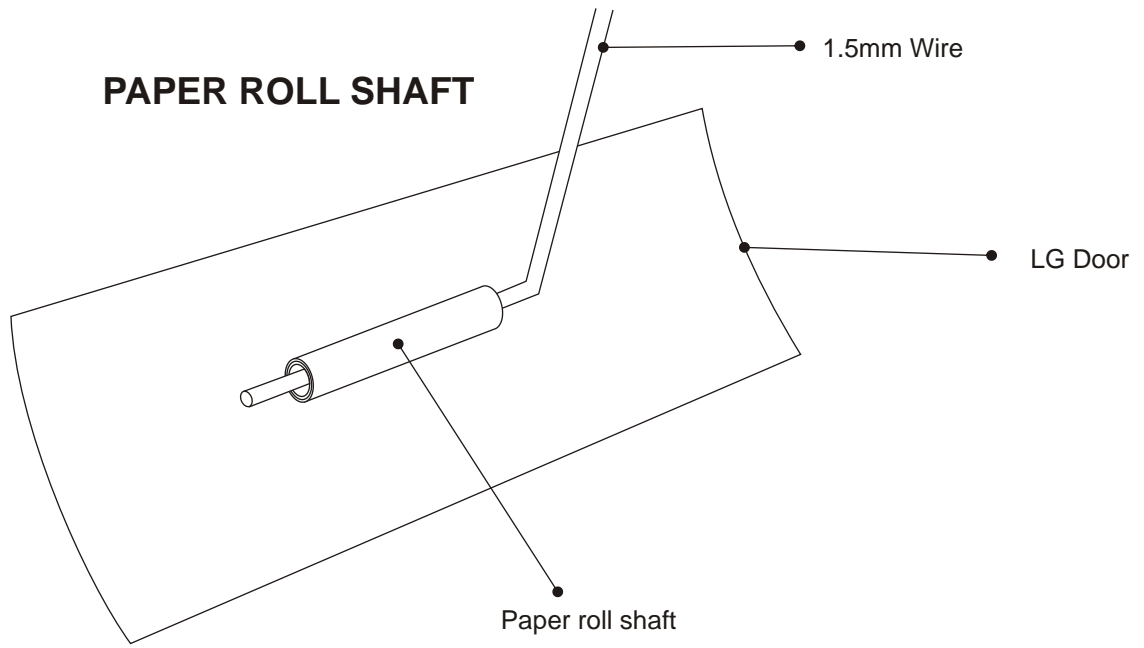

JOIN HERE

JOIN HERE

JOIN HERE

F1

## FIXED LANDING GEAR

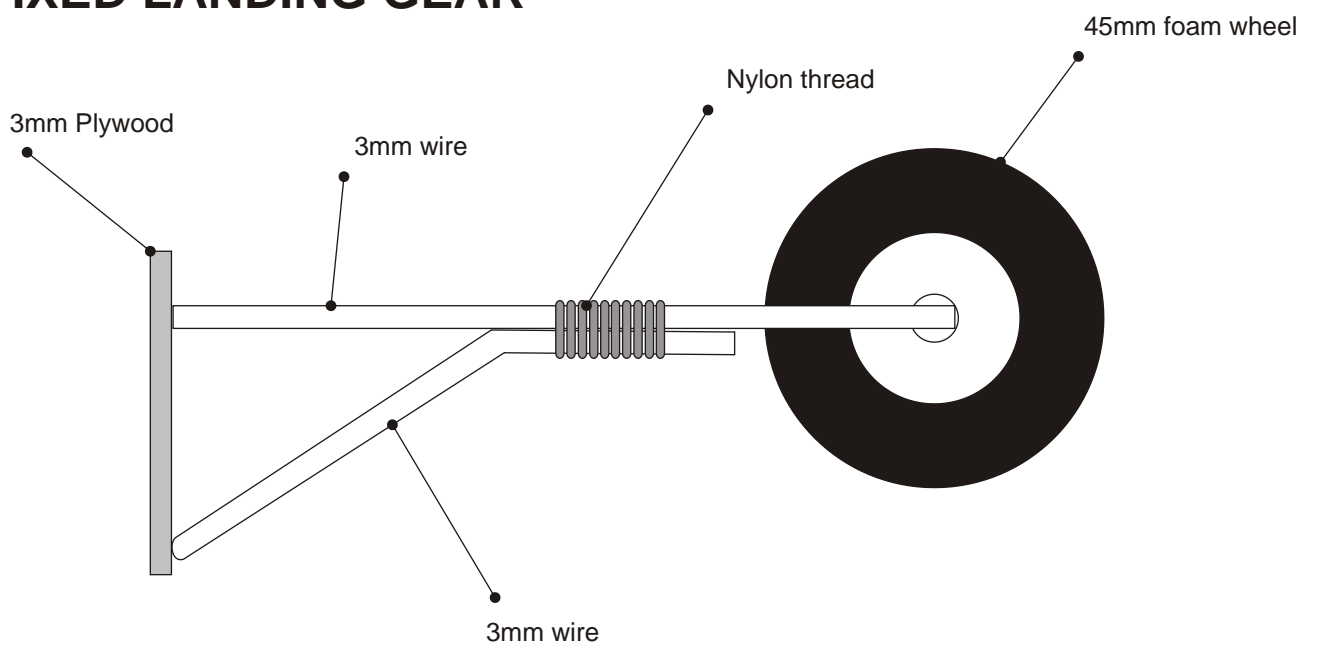

JOIN HERE

JOIN HERE

JOIN HERE

F1

F3

## FIXED LANDING GEAR

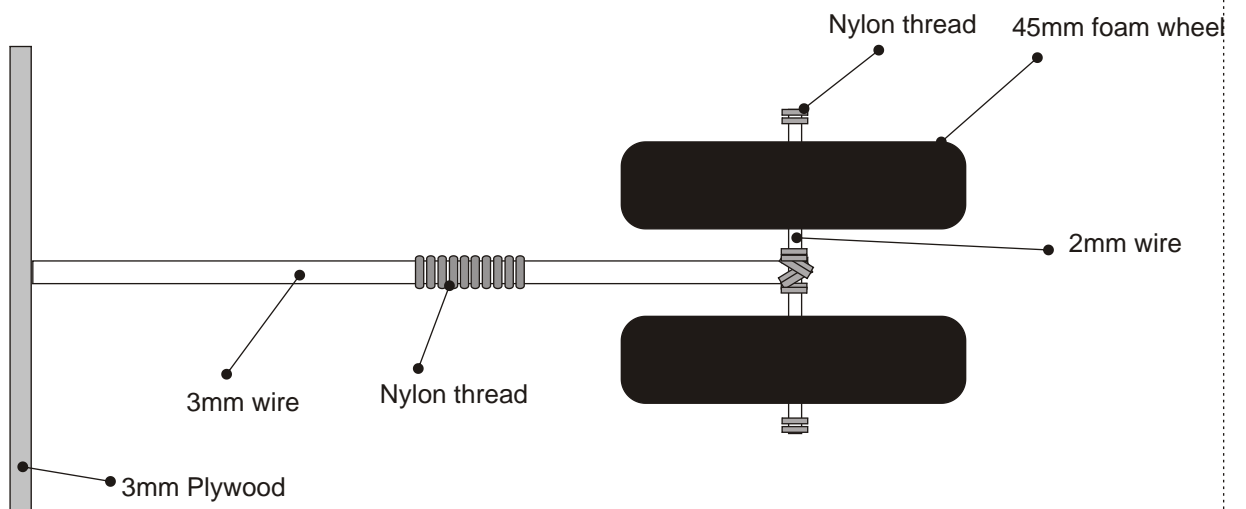

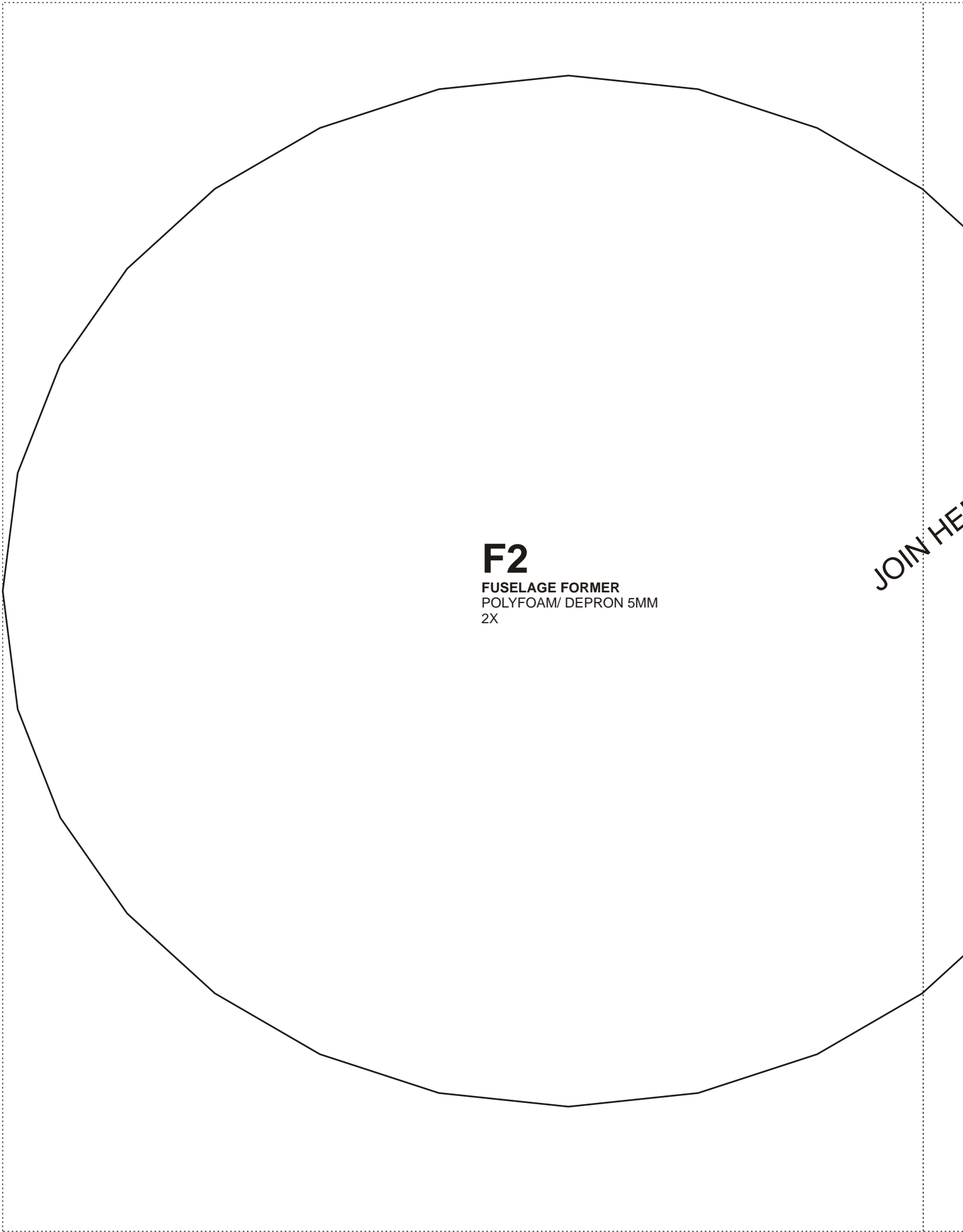

# F2

FUSELAGE FORMER  
POLYFOAM/ DEPRON 5MM  
2X

JOIN HERE

JOIN HERE

F3

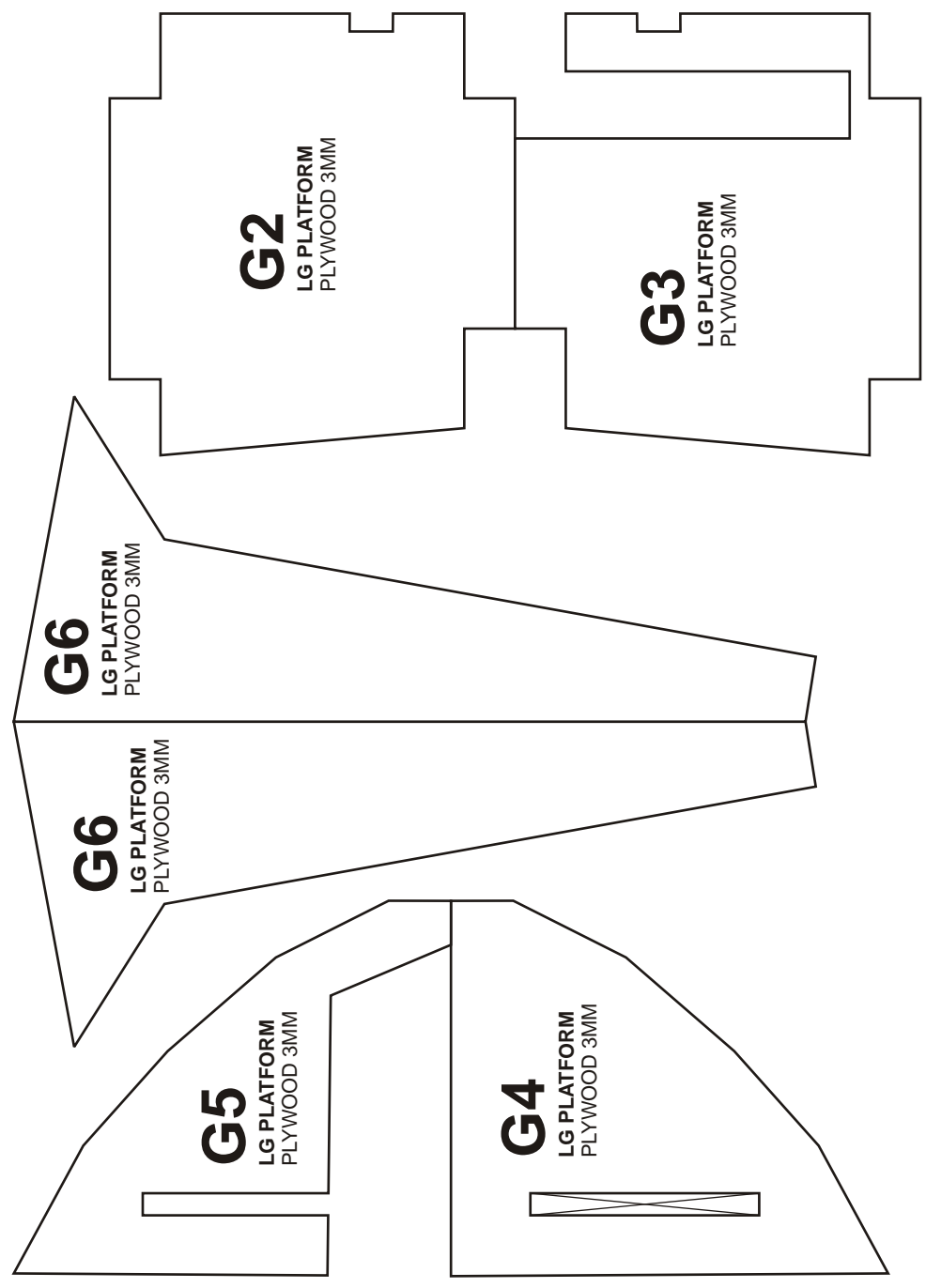



**F4**

FUSELAGE  
POLYFOAM/ DEPRON 5MM

JOIN HERE



JOIN HERE

F4

JOIN HERE

JOIN HERE

**F4**

**F5**

FUSELAGE  
POLYFOAM/ DEPRON 5MM

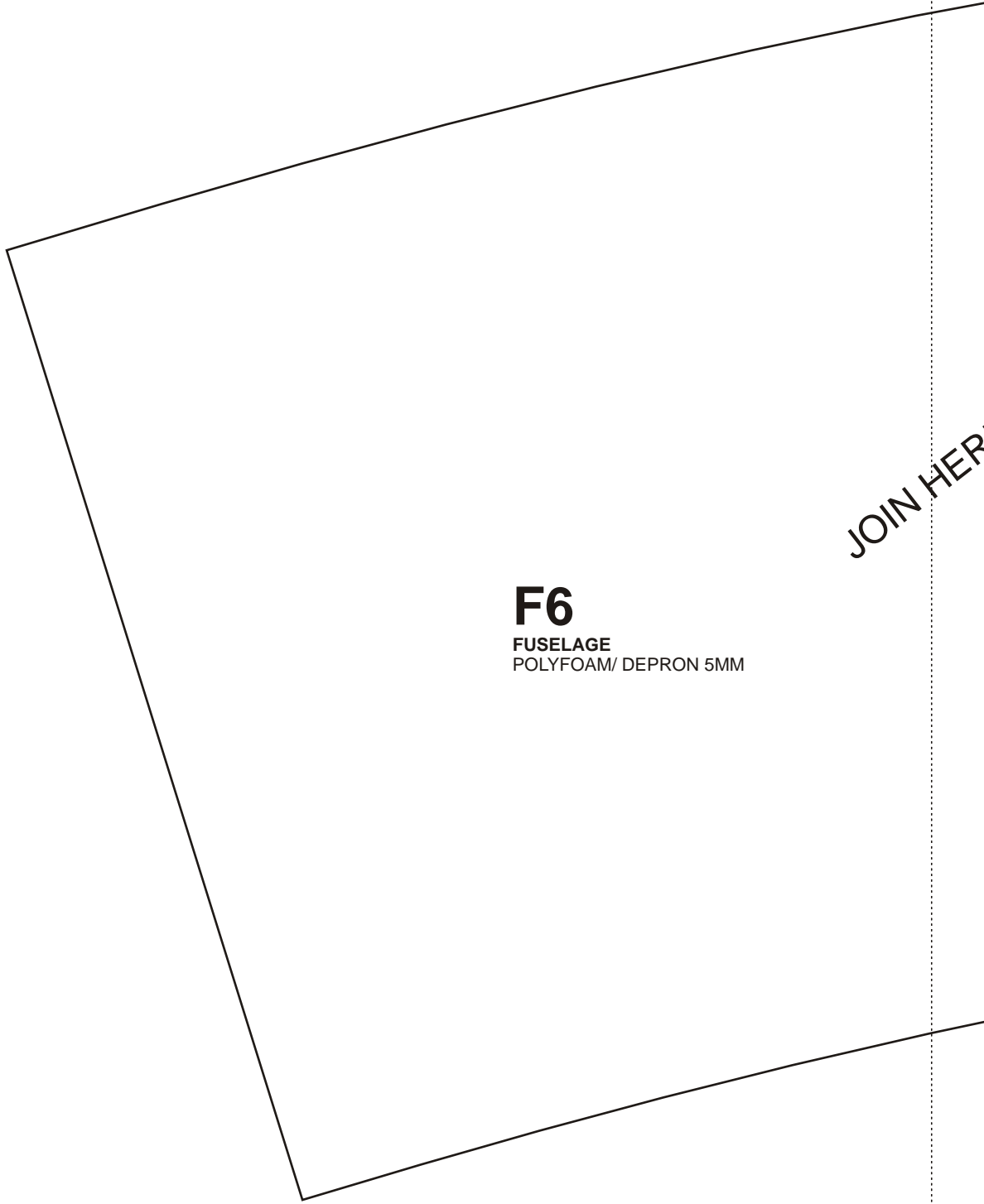

**F6**

FUSELAGE  
POLYFOAM/ DEPRON 5MM

JOIN HERE

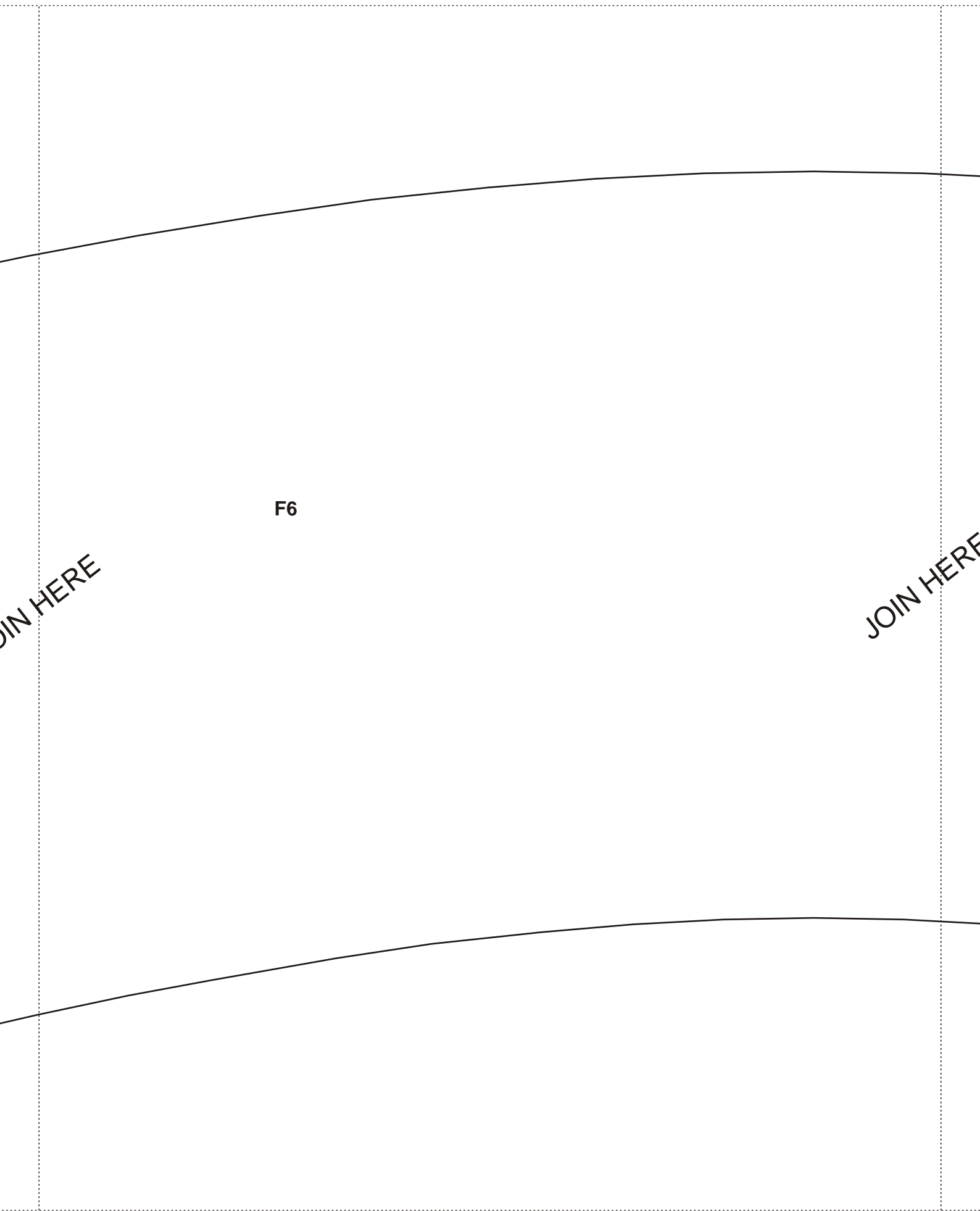

F6

JOIN HERE

JOIN HERE

JOIN HERE

F6

JOIN HERE

JOIN HERE

F6

**F14**

FUSELAGE  
POLYFOAM/ DEPRON 5MM

**G1**

LG PLATFORM  
PLYWOOD 3MM

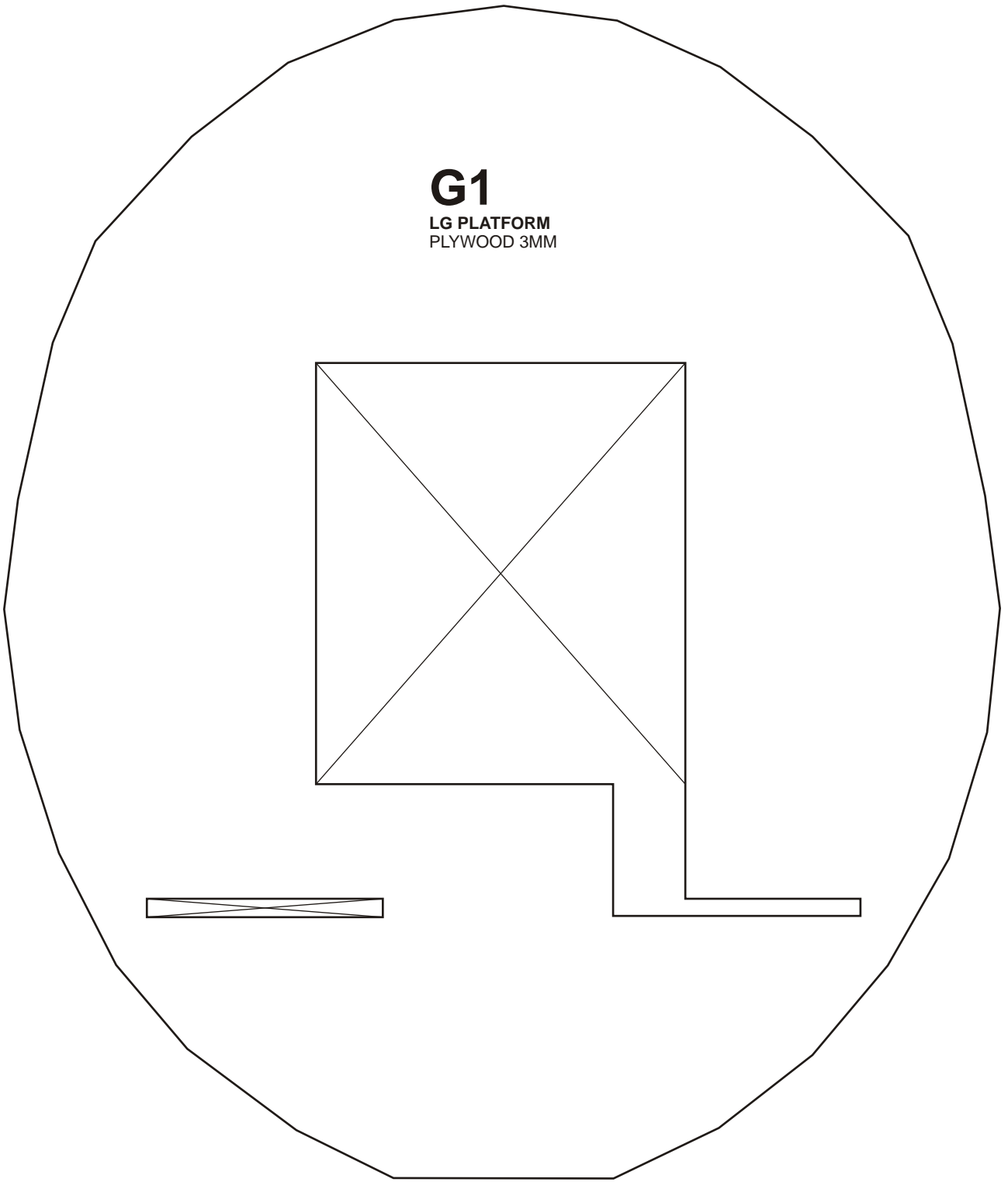



**F7**

NOSE SECTION  
POLYFOAM/ DEPRON 5MM

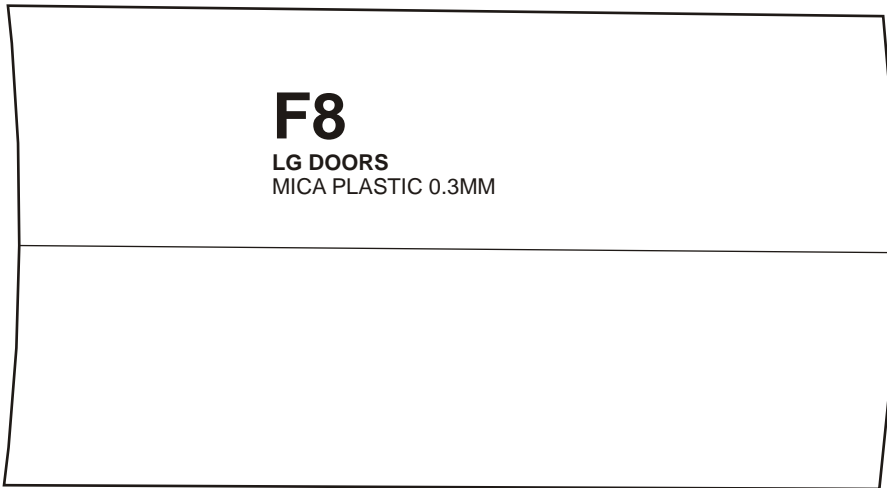

**F8**

LG DOORS  
MICA PLASTIC 0.3MM



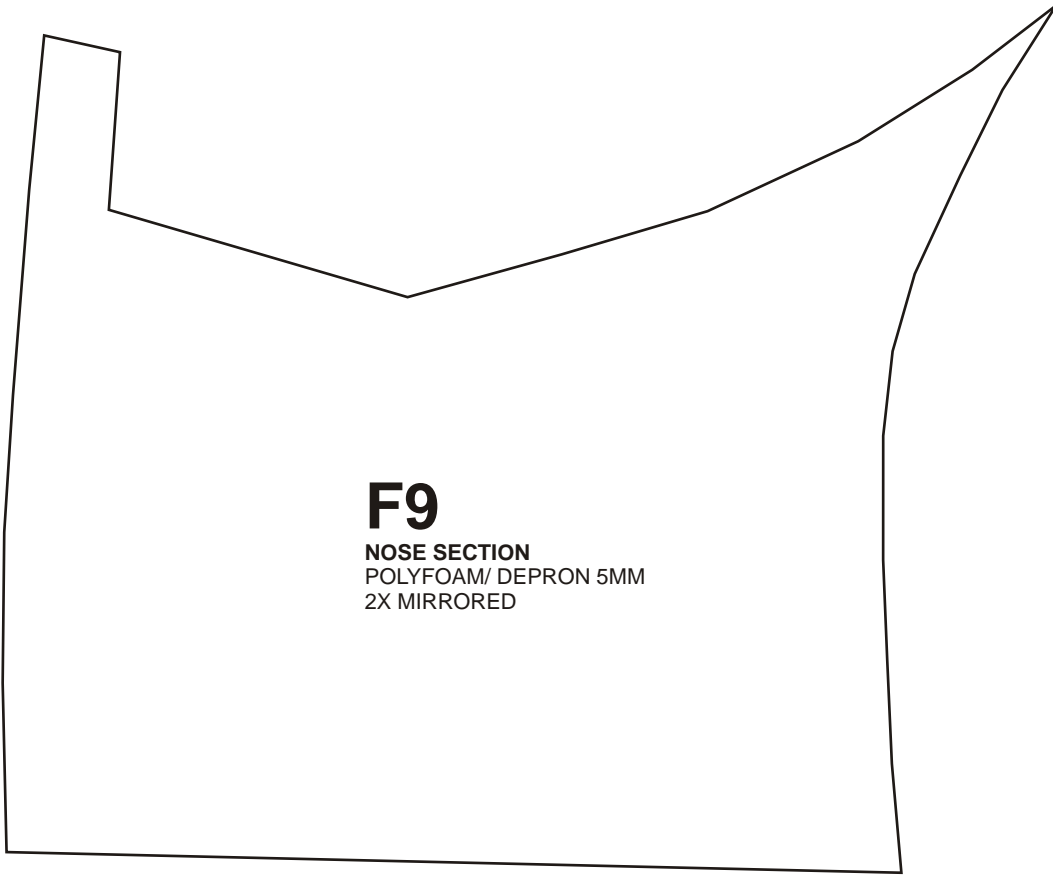

**F9**

**NOSE SECTION**  
POLYFOAM/ DEPRON 5MM  
2X MIRRORED

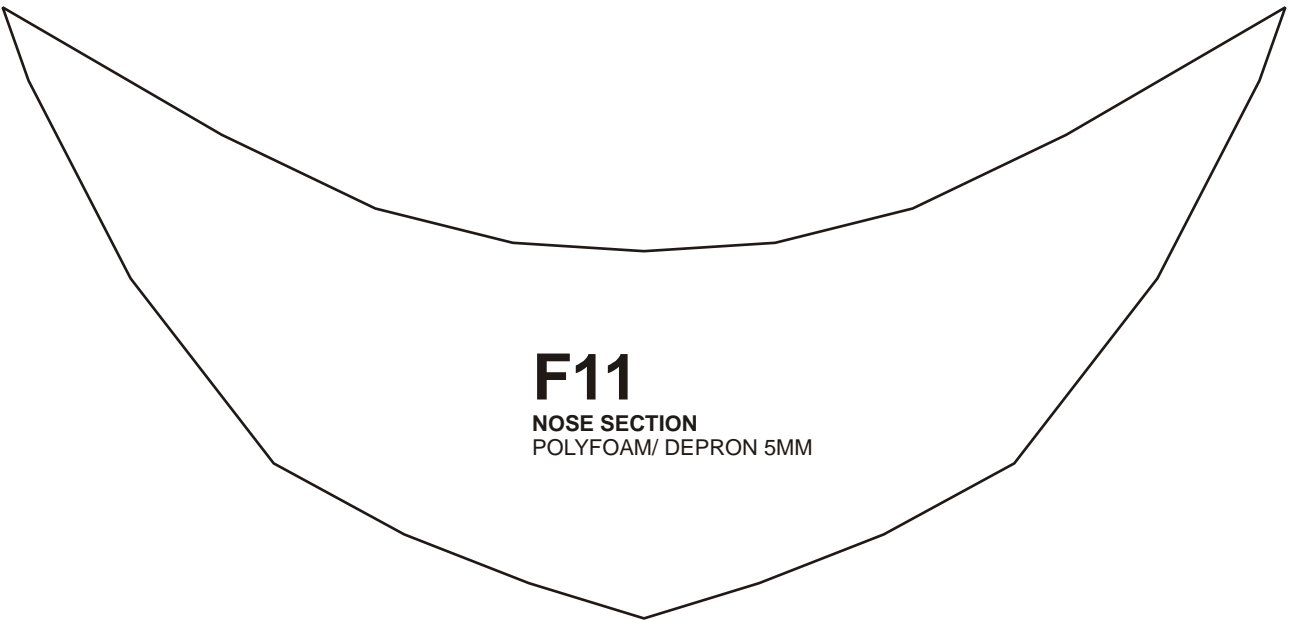

**F11**

**NOSE SECTION**  
POLYFOAM/ DEPRON 5MM

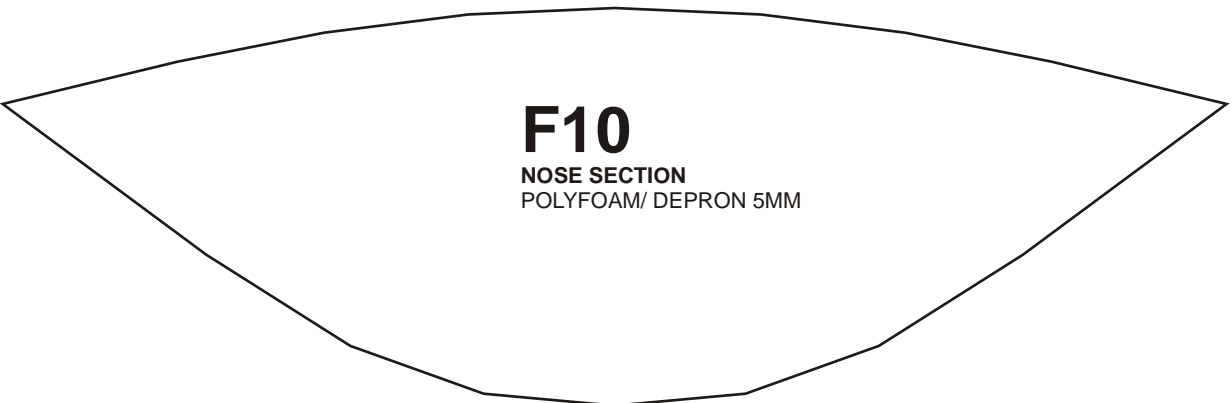

**F10**

**NOSE SECTION**  
POLYFOAM/ DEPRON 5MM

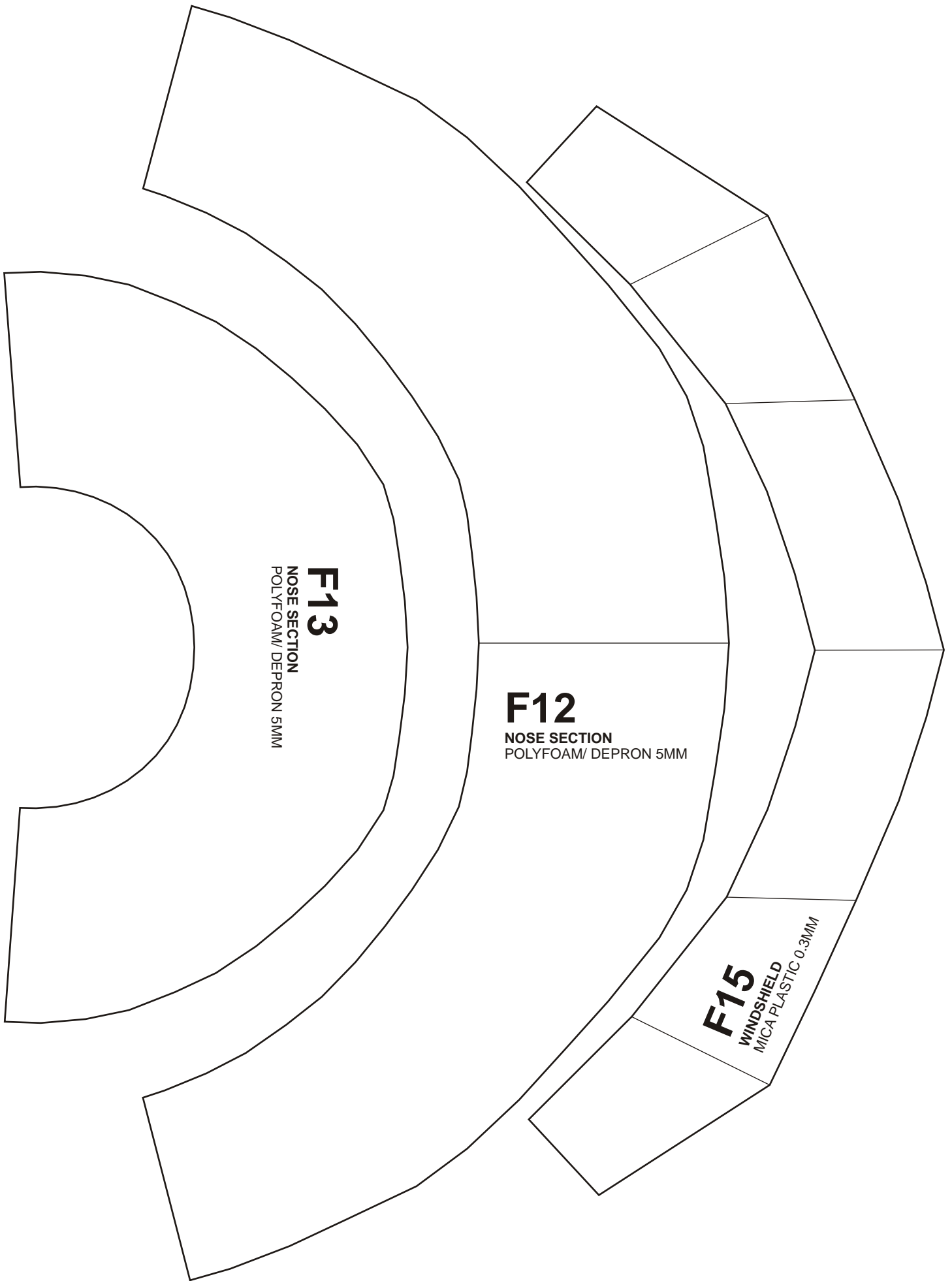

**F13**  
NOSE SECTION  
POLYFOAM/ DEPRON 5MM

**F12**  
NOSE SECTION  
POLYFOAM/ DEPRON 5MM

**F15**  
WINDSHIELD  
MICA PLASTIC 0.3MM

# T1

BELLY FAIRING GUIDE  
TRACE IT WITH PEN

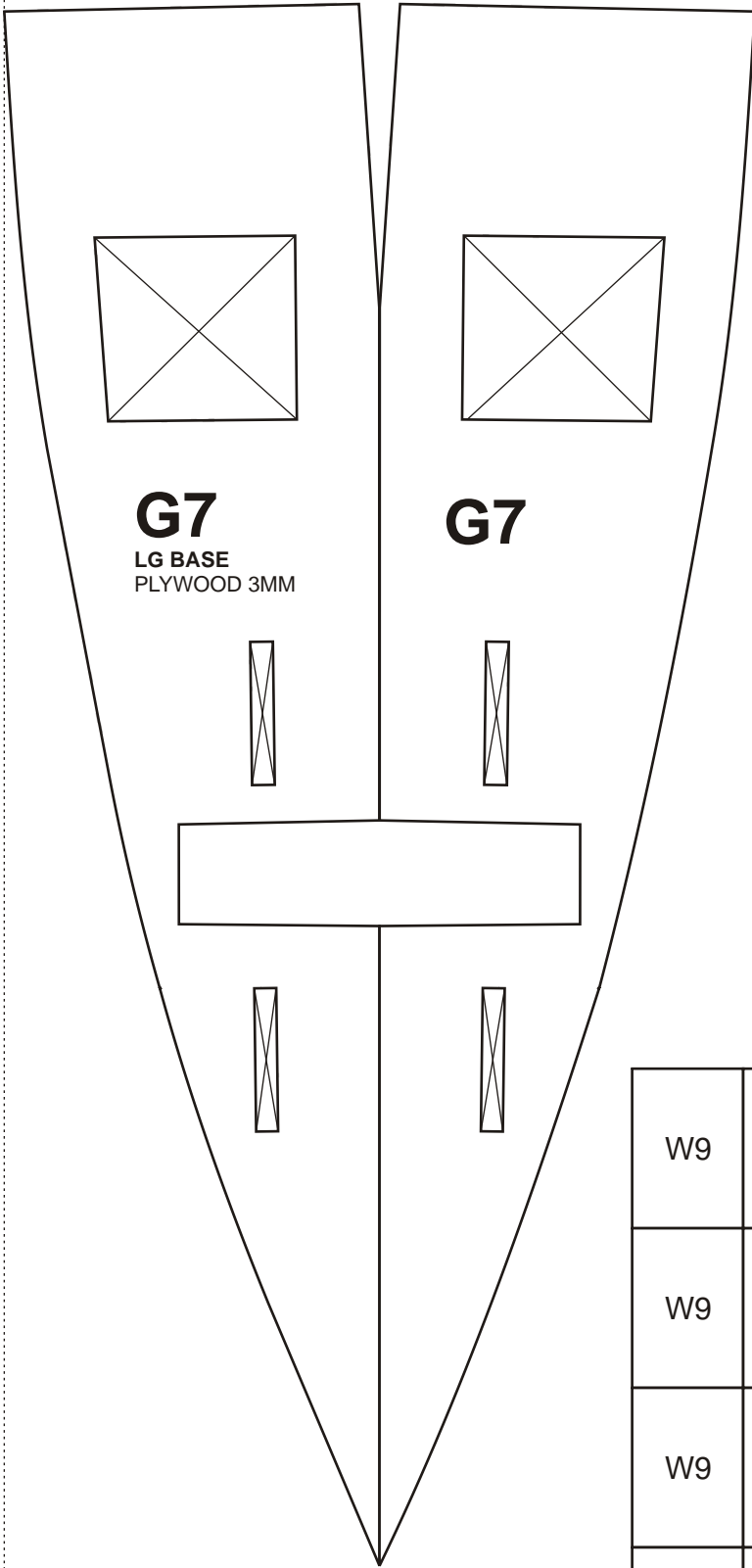

**G7**  
LG BASE  
PLYWOOD 3MM

**G7**

**W9**  
WING JOINER  
PLYWOOD 3MM

W9	W9	W9
W9	W9	W9
W9	W9	W9
W9	W9	W9

JOIN HERE

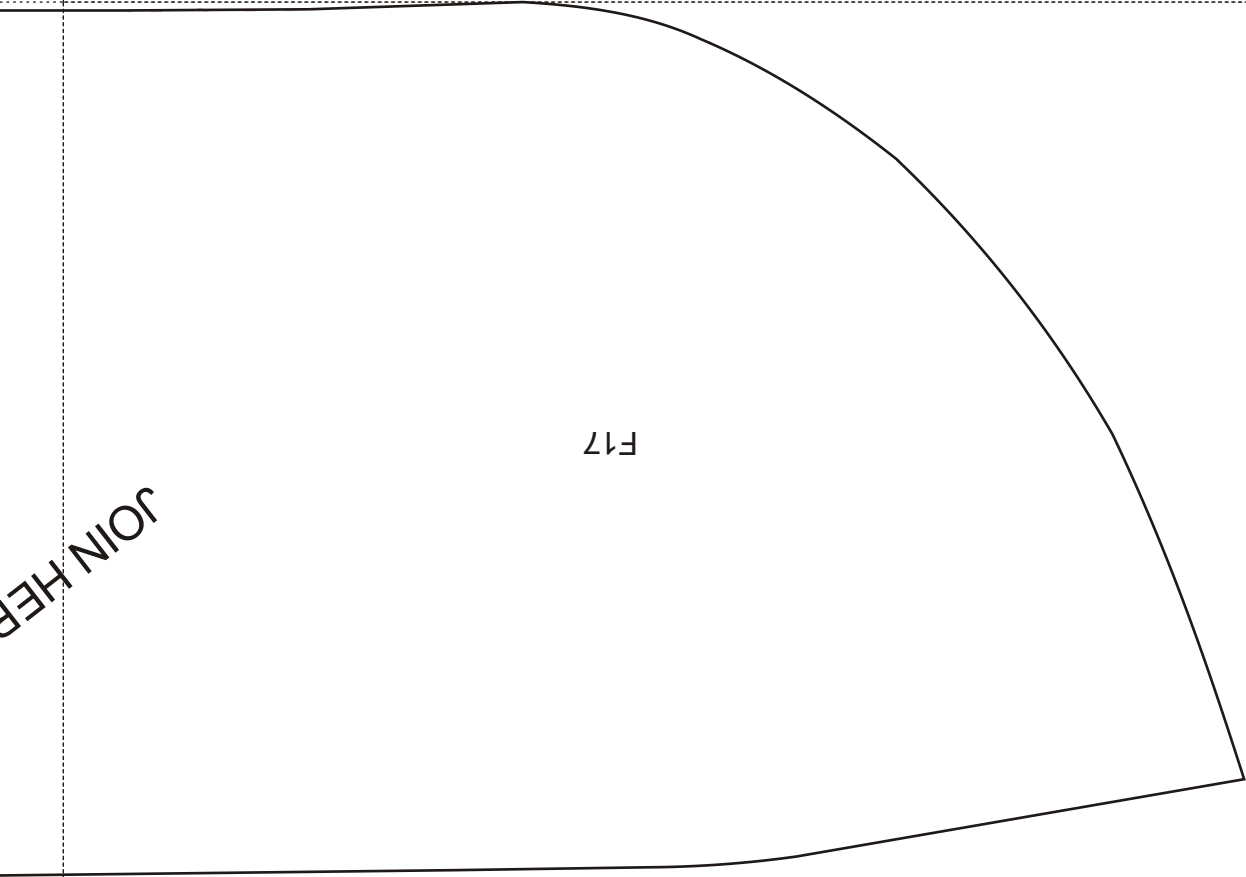

F17

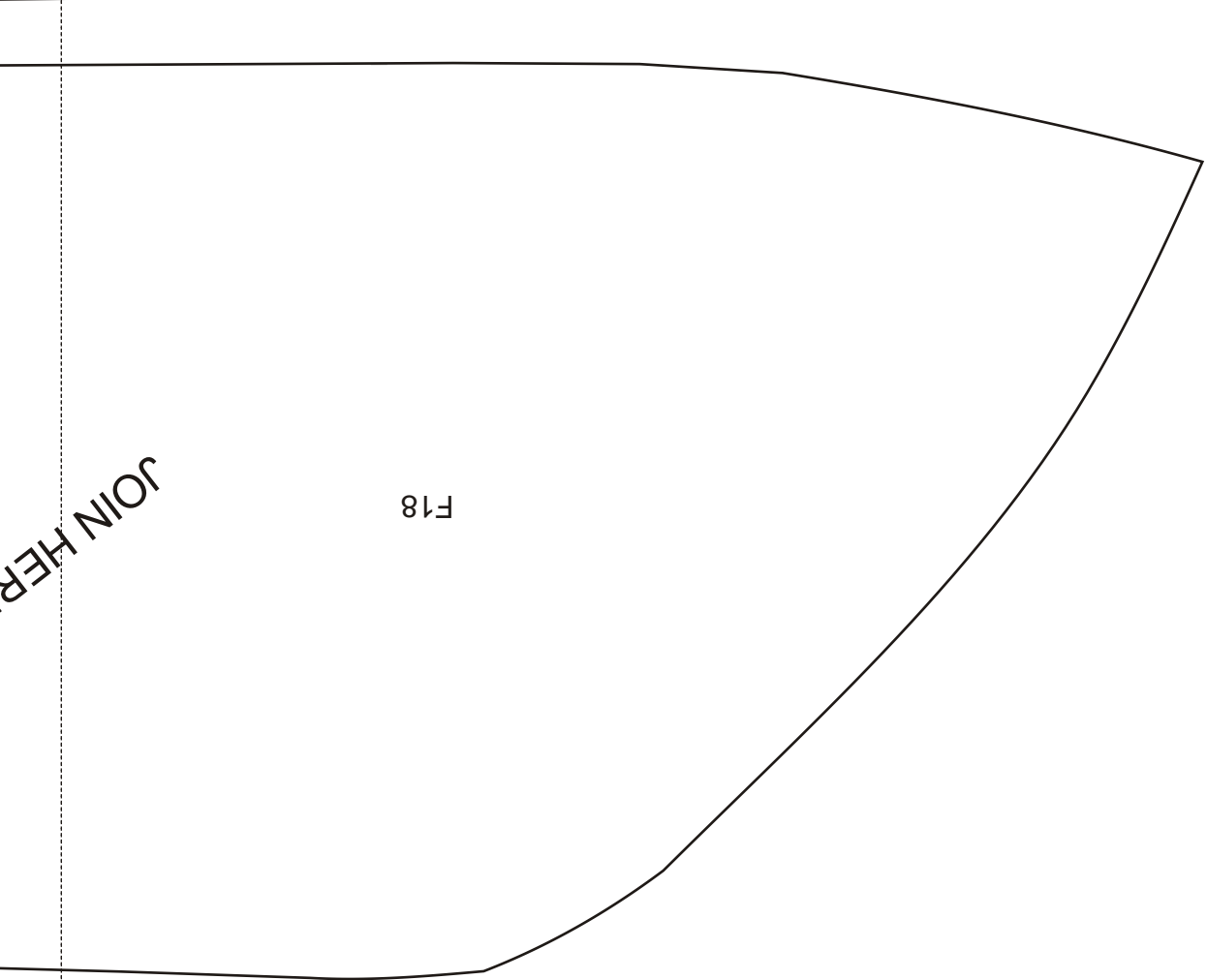

F18

JOIN HERE

L1

JOIN HERE

JOIN HERE

JOIN HERE

JOIN HERE

T1



# F19

BELLY FAIRING  
POLYFOAM/ DEPRON 5MM

JOIN HERE

JOIN HERE

F19

JOIN HERE

JOIN HERE

JOIN HERE

JOIN HERE

F19



JOIN HERE

JOIN HERE

F19

FRONT



JOIN HERE

**F18**

BELLY FAIRING  
POLYFOAM/ DEPRON 5MM

JOIN HERE

**F17**

BELLY FAIRING  
POLYFOAM/ DEPRON 5MM

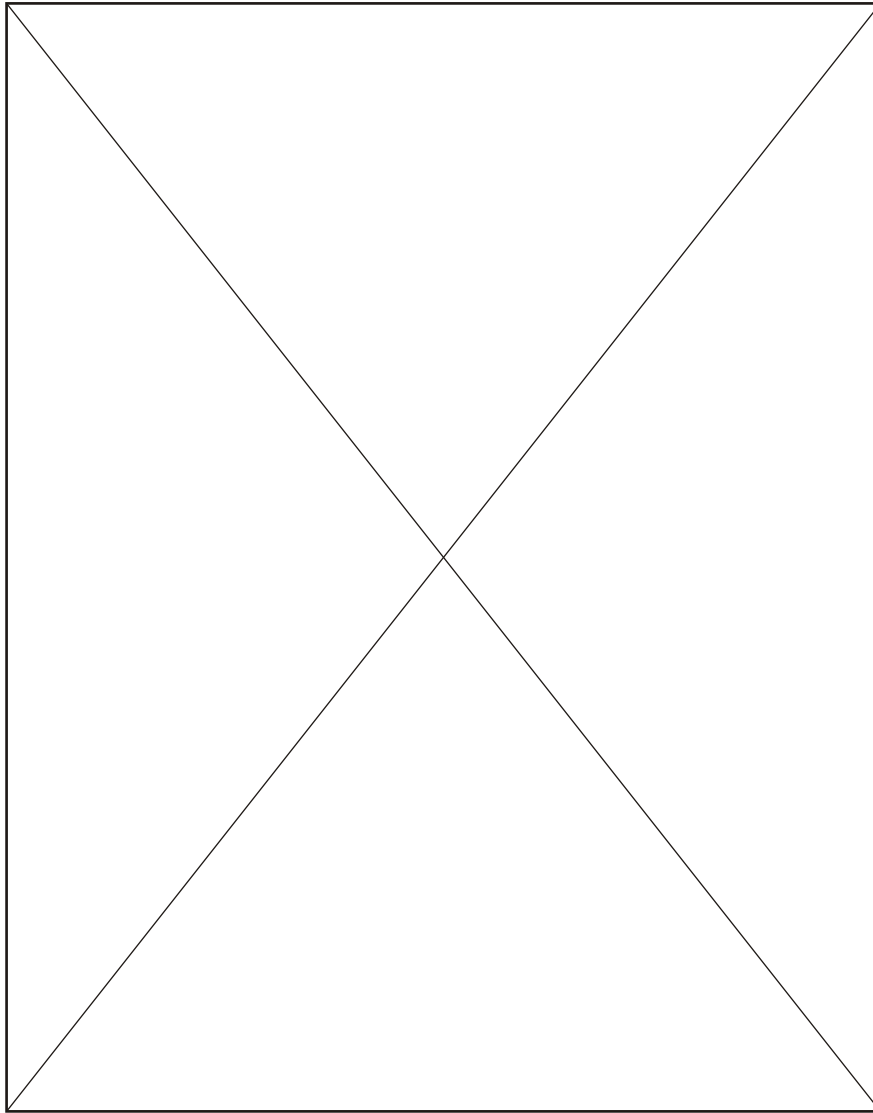

**F16**  
FUSELAGE FORMER  
POLYFOAM/ DEPRON 5MM

JOIN HERE

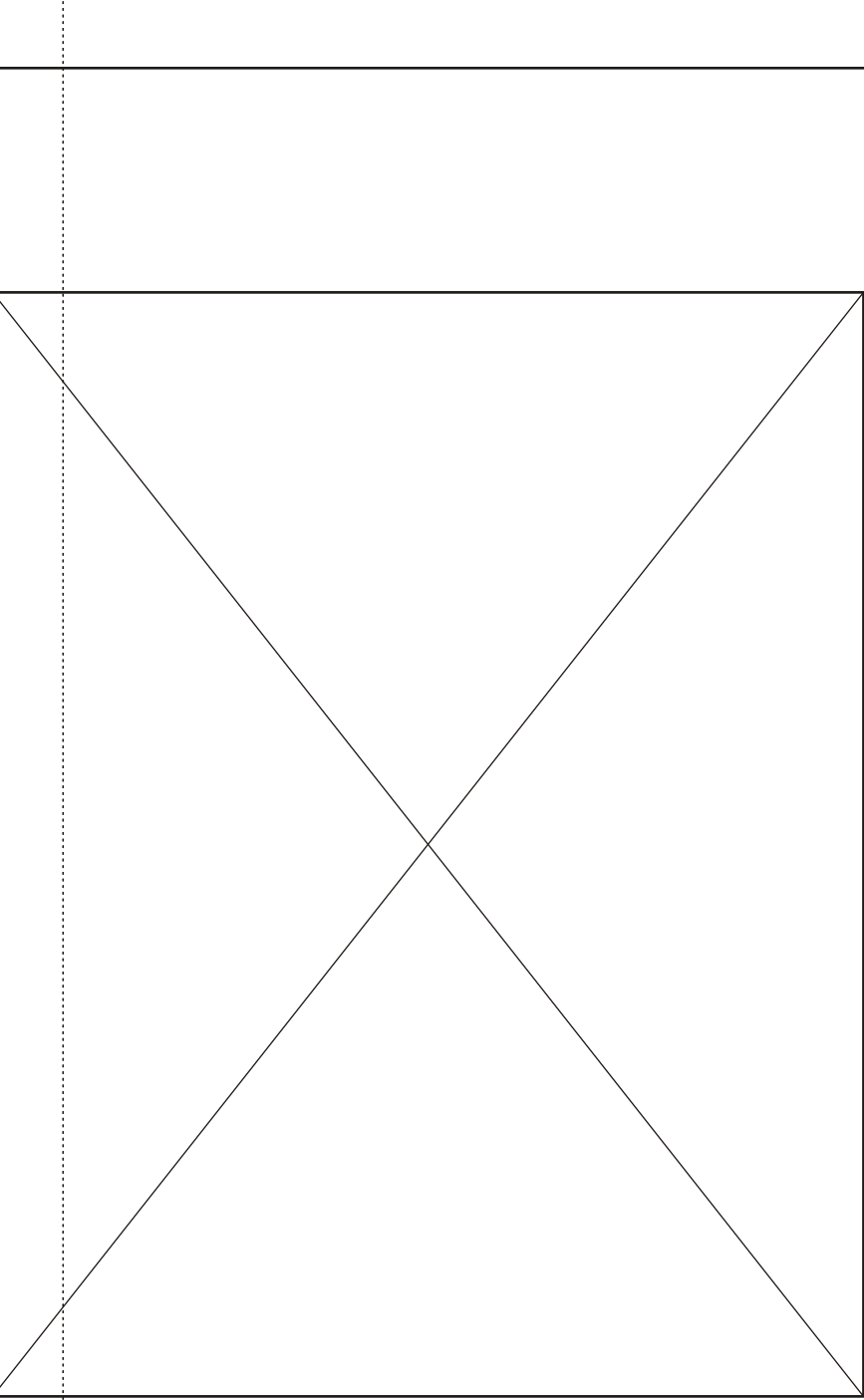

JOIN HERE

F16

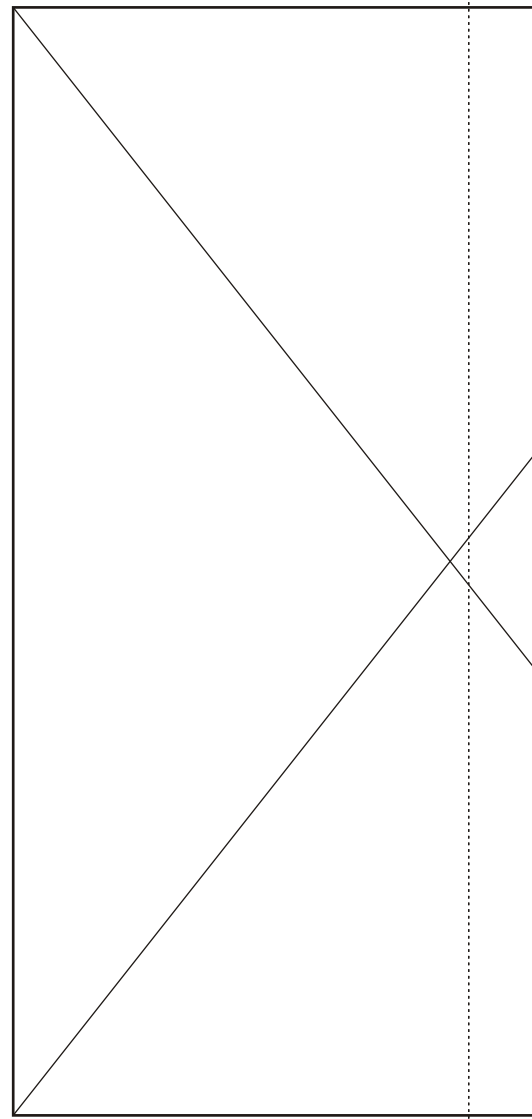

JOIN HERE

JOIN HERE

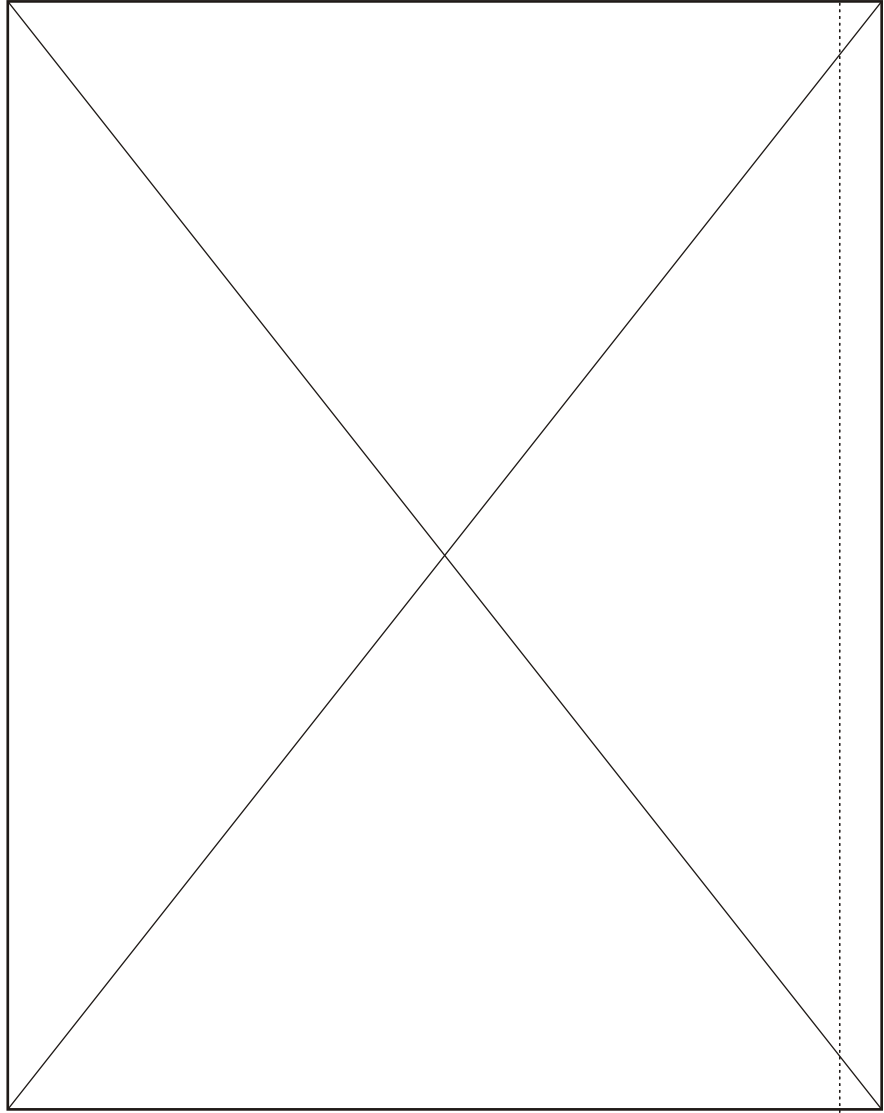
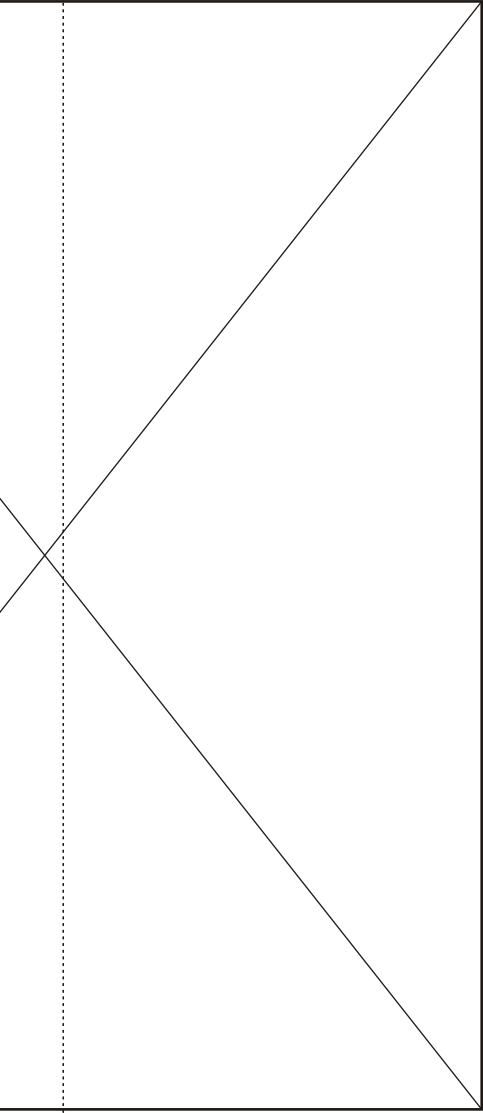

JOIN HERE

JOIN HERE

**W11**  
WING SPAR  
PLYWOOD 3MM

**W11**  
WING SPAR  
PLYWOOD 3MM

**W2**  
WING SPAR  
POLYFOAM/  
DEPRON 5MM  
2X

JOIN HERE

JOIN HERE

JOIN HERE

JOIN HERE

W11

JOIN HERE

W2

JOIN HERE

W11

**W8**

**WING FORMER**  
POLYFOAM/ DEPRON 5MM  
4X

**W6**

**LG BASE GUIDE**  
POLYFOAM/ DEPRON 5MM  
2X

**W4**

**LG BASE GUIDE**  
POLYFOAM/ DEPRON 5MM  
2X

**W1**

**BOTTOM WING**  
POLYFOAM/ DEPRON 5MM  
2X

JOIN HERE

JOIN HERE



JOIN HERE

W1

JOIN HERE

**W5**

LG BASE GUIDE  
POLYFOAM/  
DEPRON 5MM  
2X

**W3**

WING FORMER  
POLYFOAM/  
DEPRON 5MM  
2X

JOIN HERE

JOIN HERE

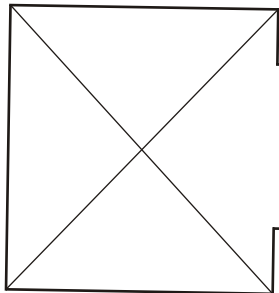

W1

JOIN HERE

**W8**

WING FORMER  
POLYFOAM/  
DEPRON 5MM  
4X

JOIN HERE

JOIN HERE

JOIN HERE

W3

JOIN HERE

W1

JOIN HERE

W8

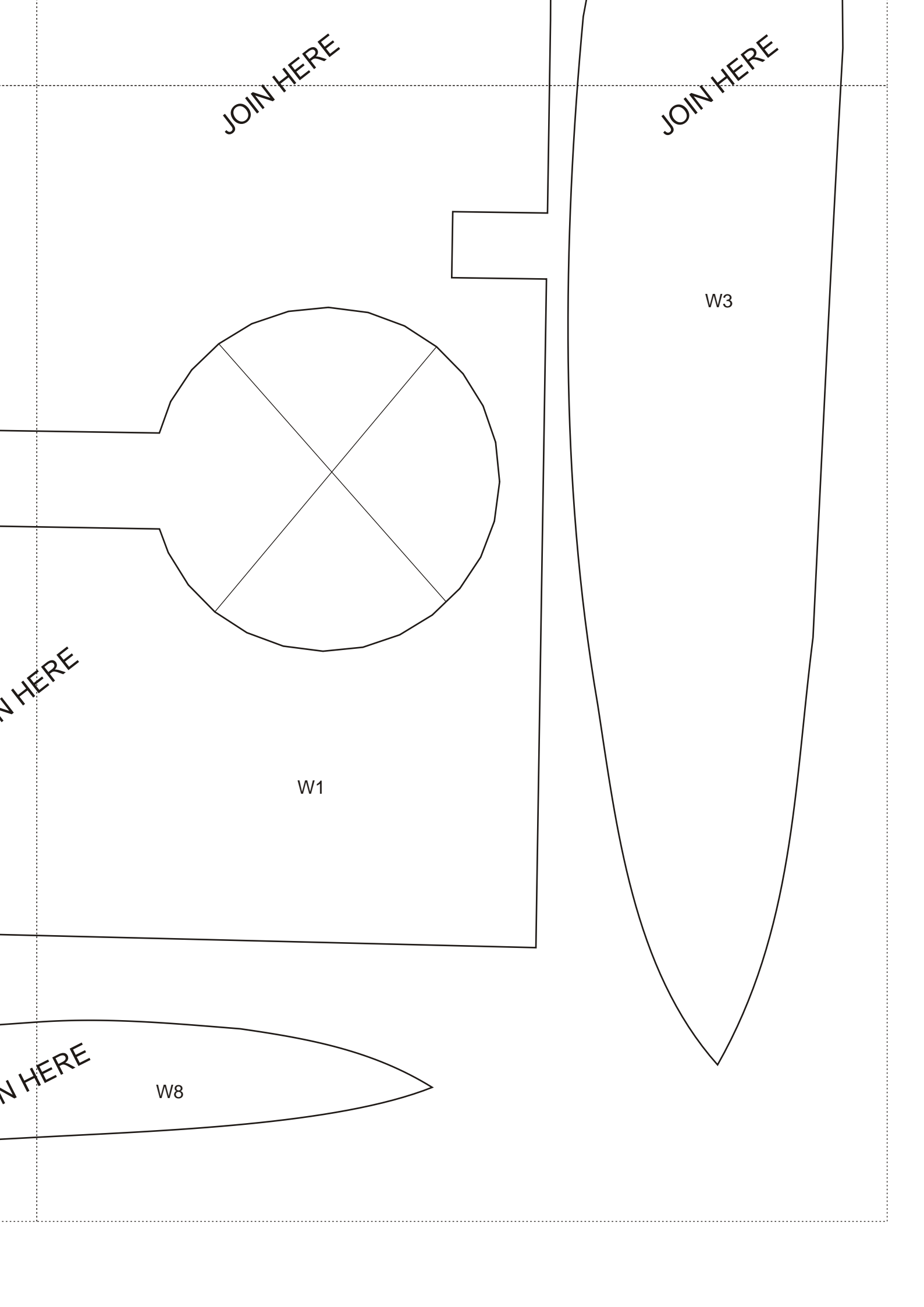

# W10

TOP WING  
POLYFOAM/ DEPRON 5MM  
2X

JOIN HERE

JOIN HERE

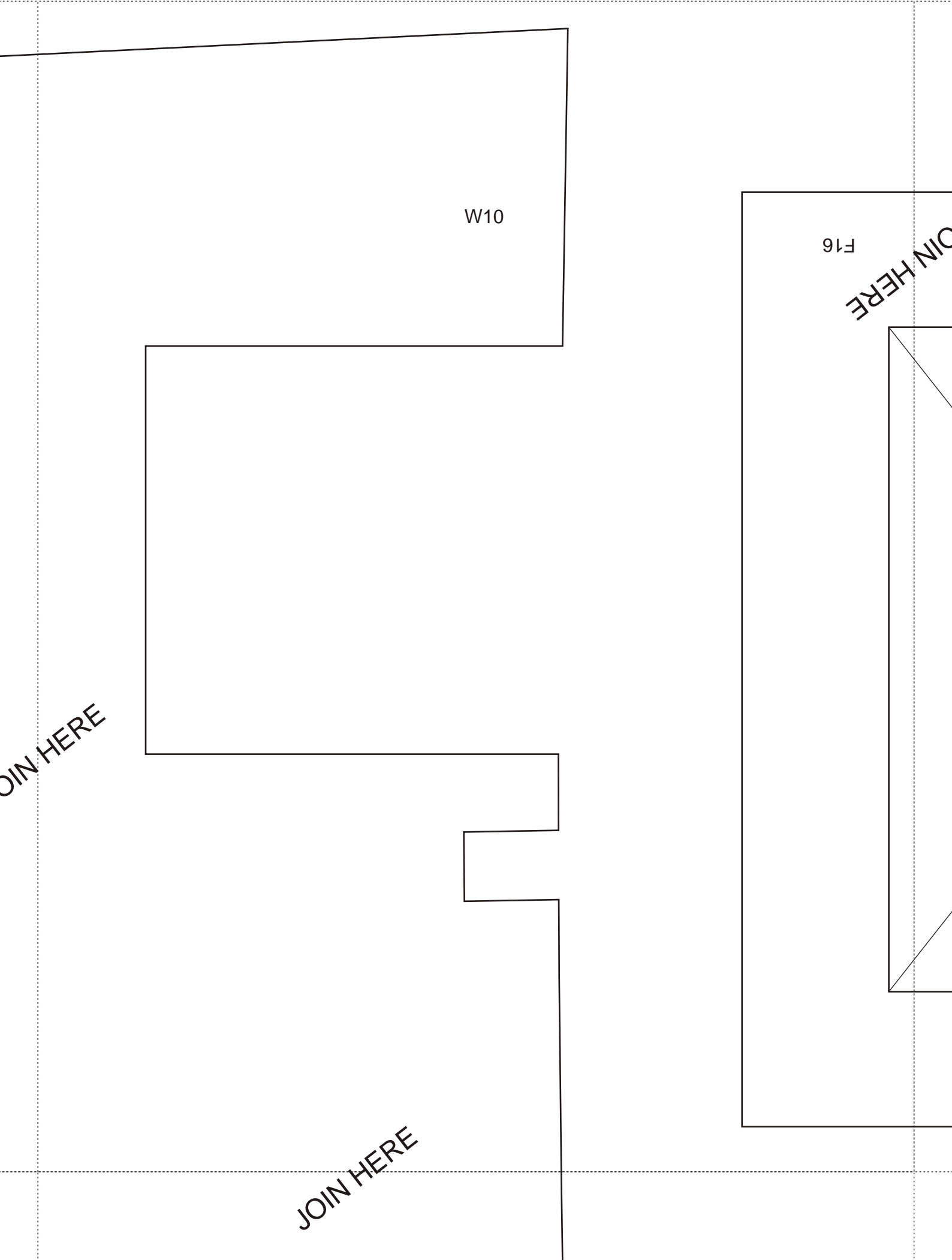

W10

F16

JOIN HERE

JOIN HERE

JOIN HERE

JOIN HERE

W10

JOIN HERE

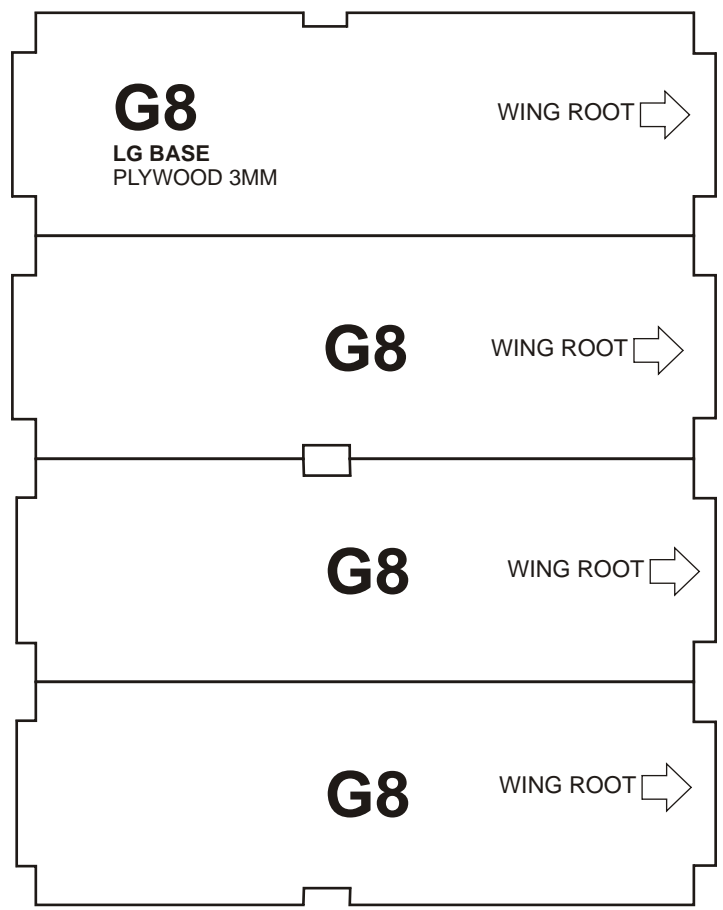

JOIN HERE

JOIN HERE

W10

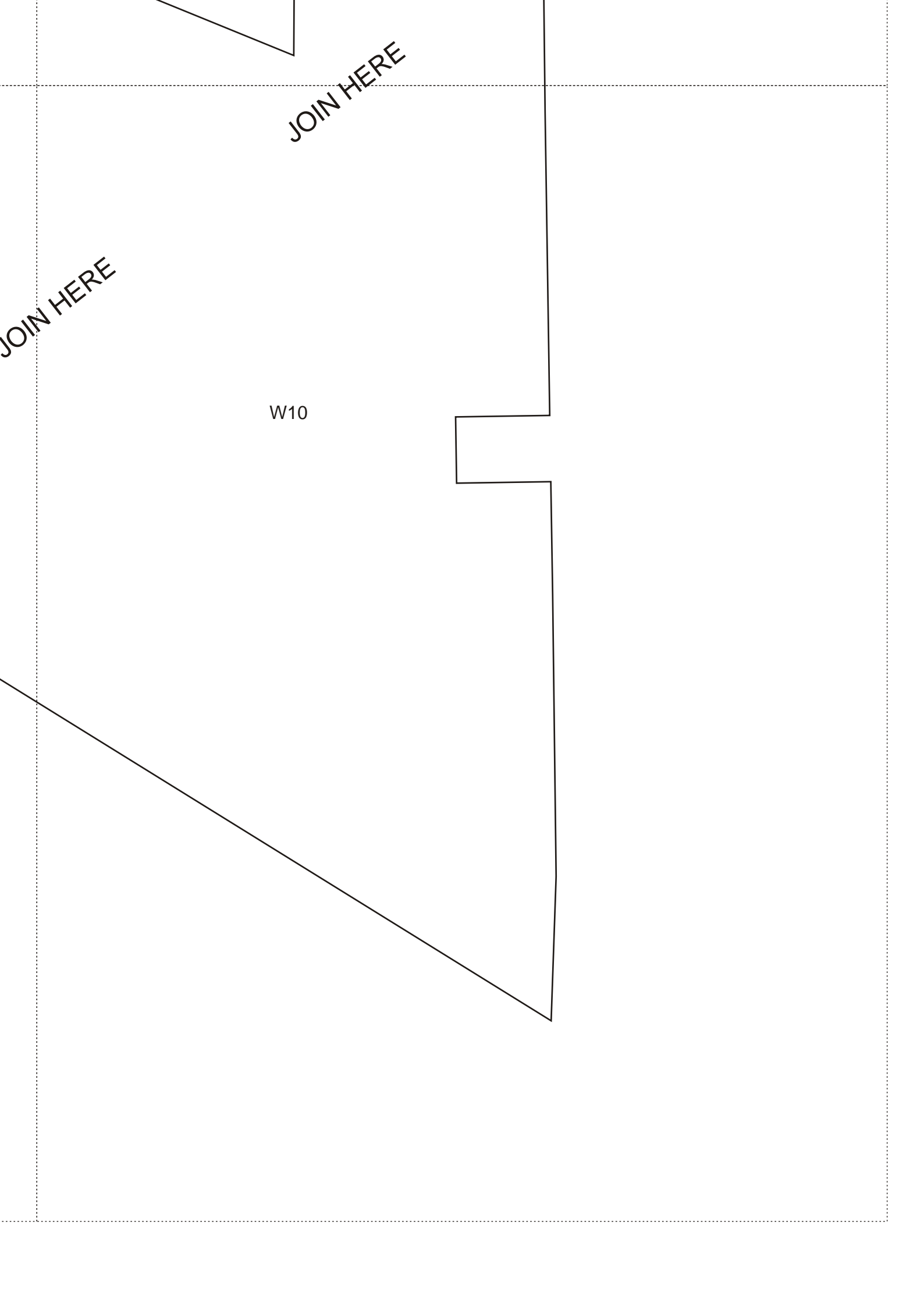

**W15**

WING SPAR  
PLYWOOD 3MM  
2X

**T2**

AILERON GUIDE  
TRACE WITH PEN

**W13**

WING FORMER  
POLYFOAM/  
DEPRON 5MM  
4X

JOIN HERE



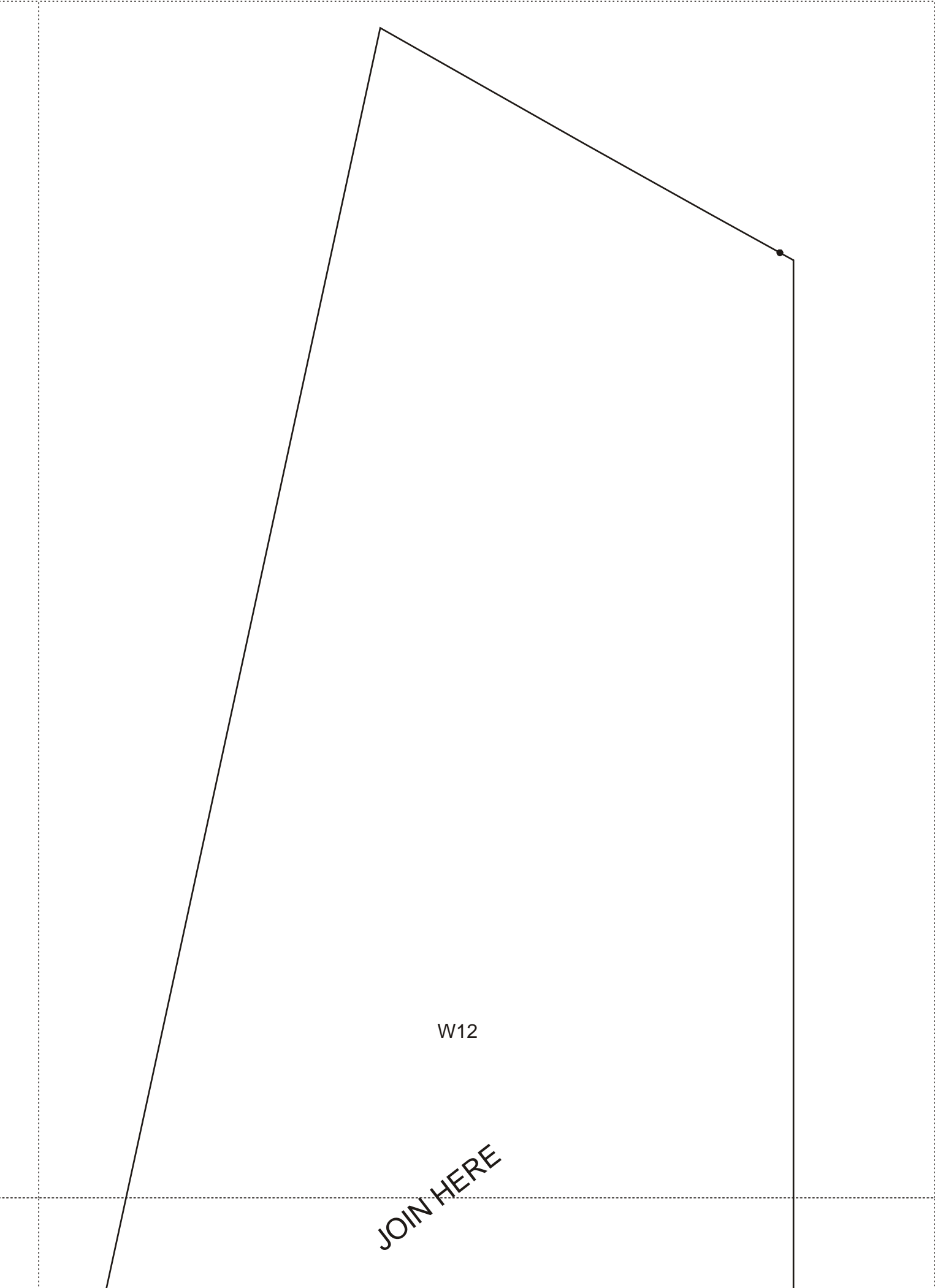

W12

JOIN HERE

JOIN HERE

W15

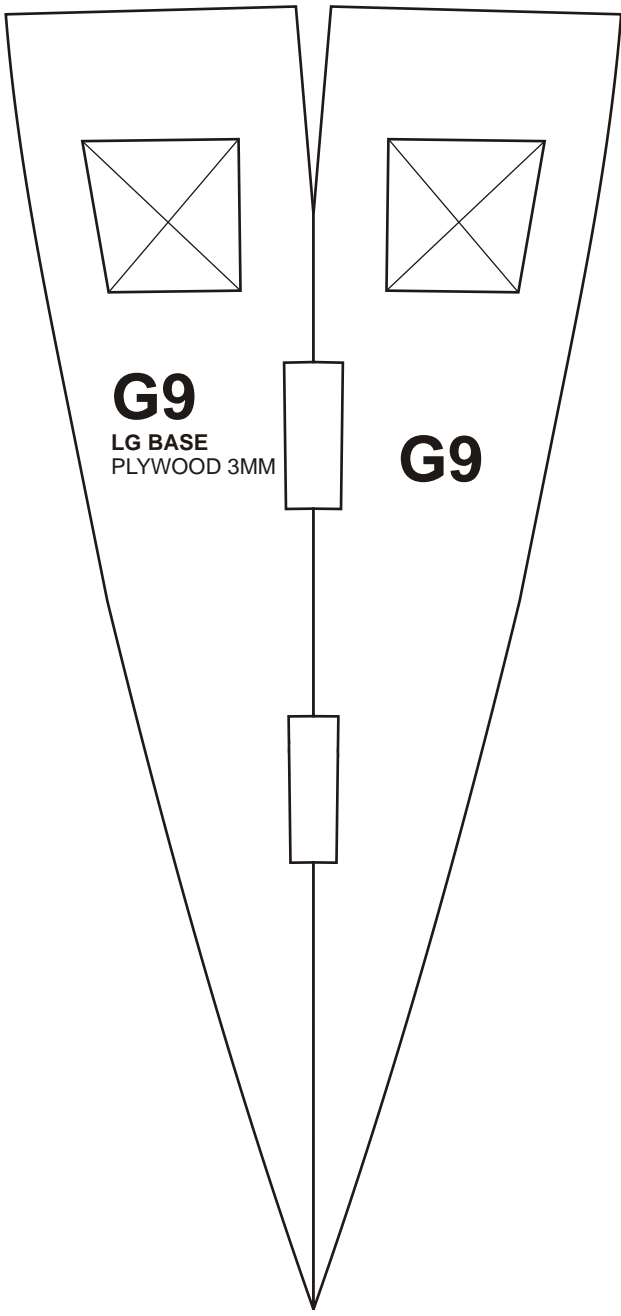

JOIN HERE

W12

JOIN HERE

JOIN HERE

JOIN HERE

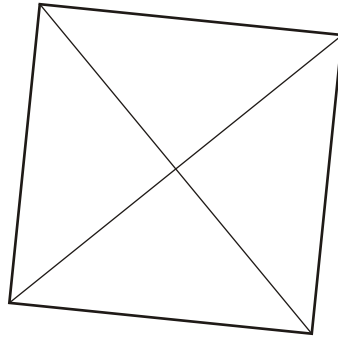

W12

JOIN HERE

RE

JOIN HERE

W15 JOIN HERE

JOIN HERE

JOIN HERE

**T4**

BELLY FAIRING GUIDE  
TRACE WITH PEN

W12

**T3**

BELLY FAIRING GUIDE  
TRACE WITH PEN

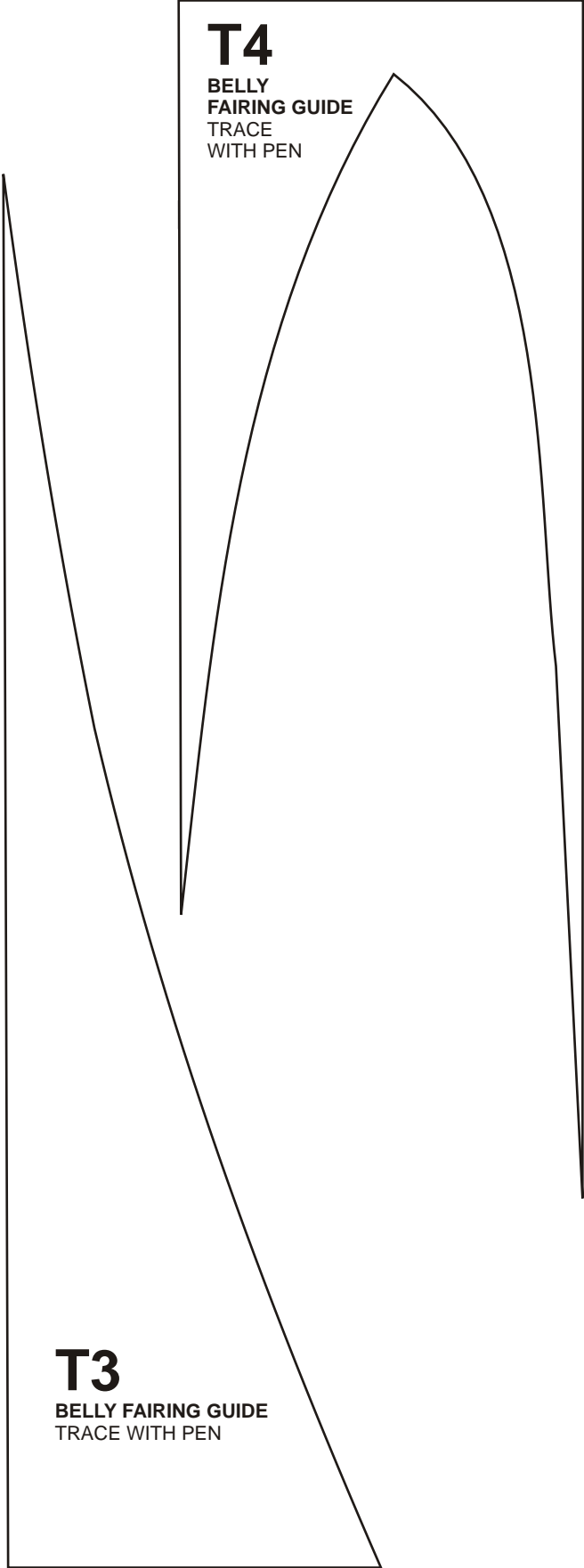

RE

JOIN HERE

JOIN HERE

W12

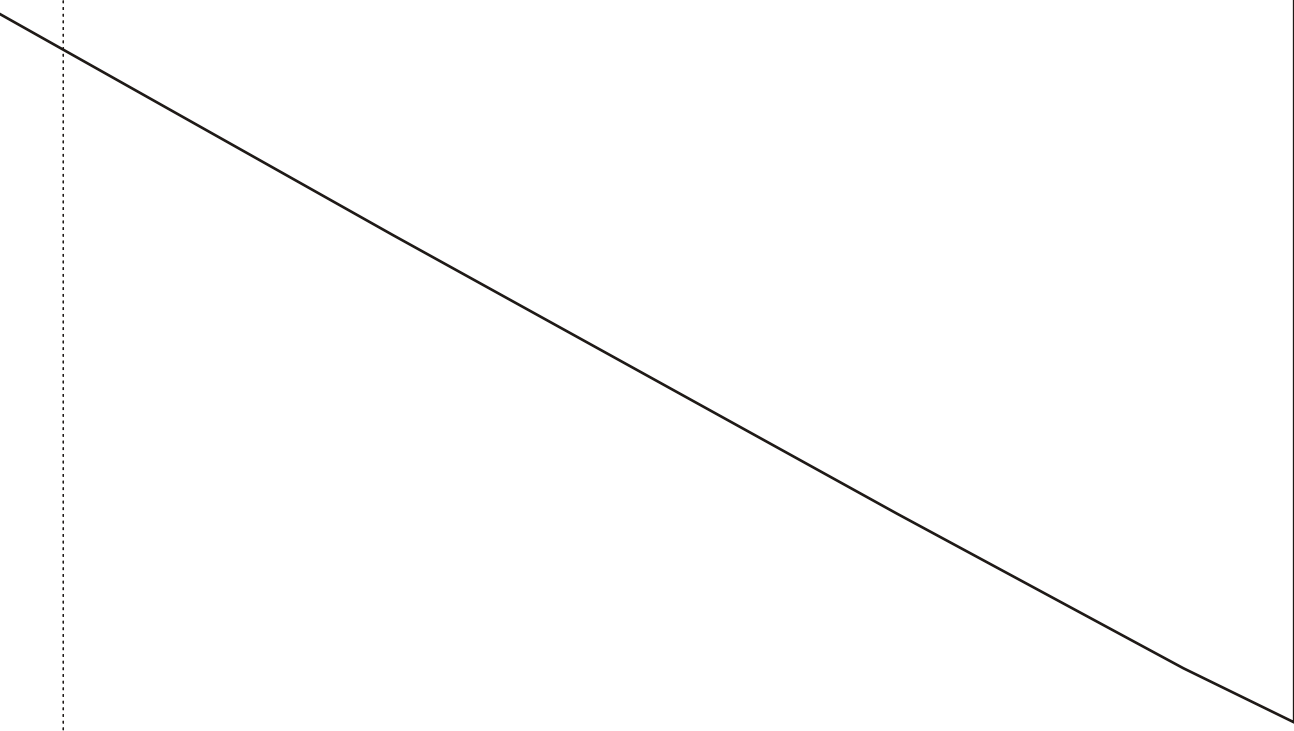

# W14

TOP WING  
POLYFOAM/ DEPRON 5MM  
2X MIRRORED

W14

JOIN HERE

HERE

JOIN HERE

JOIN HERE

W14

JOIN HERE

JOIN HERE

JOIN HERE

JOIN HE

W14

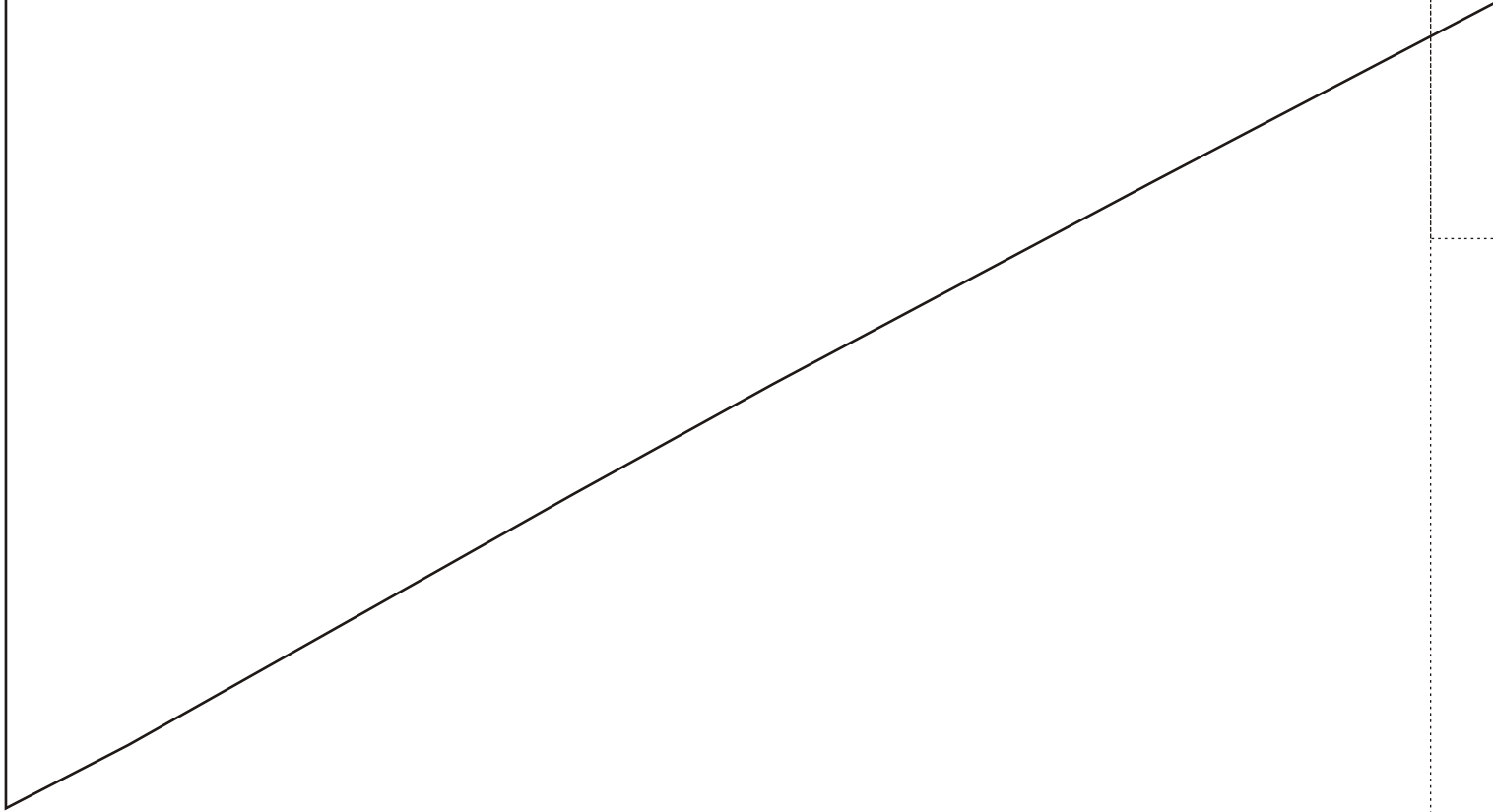



**F22**

TAIL SECTION  
POLYFOAM/  
DEPRON 5MM

JOIN HERE

JOIN HERE

**F22**

JOIN HERE

JOIN HERE

**F22**

**F23**

TAIL SECTION  
POLYFOAM/  
DEPRON 5MM



**F24**

TAIL SECTION  
POLYFOAM/  
DEPRON 5MM

JOIN HERE

JOIN HERE

F24

JOIN HERE

JOIN HERE

**F24**

**F25**

TAIL SECTION  
POLYFOAM/  
DEPRON 5MM



**F26**

TAIL SECTION  
POLYFOAM/  
DEPRON 5MM

JOIN HERE

JOIN HERE

JOIN HERE

F26



IN HERE

**F26**

**F27**

TAIL SECTION  
POLYFOAM/  
DEPRON 5MM



**F28**

TAIL SECTION  
POLYFOAM/  
DEPRON 5MM

JOIN HERE

JOIN HERE

F28

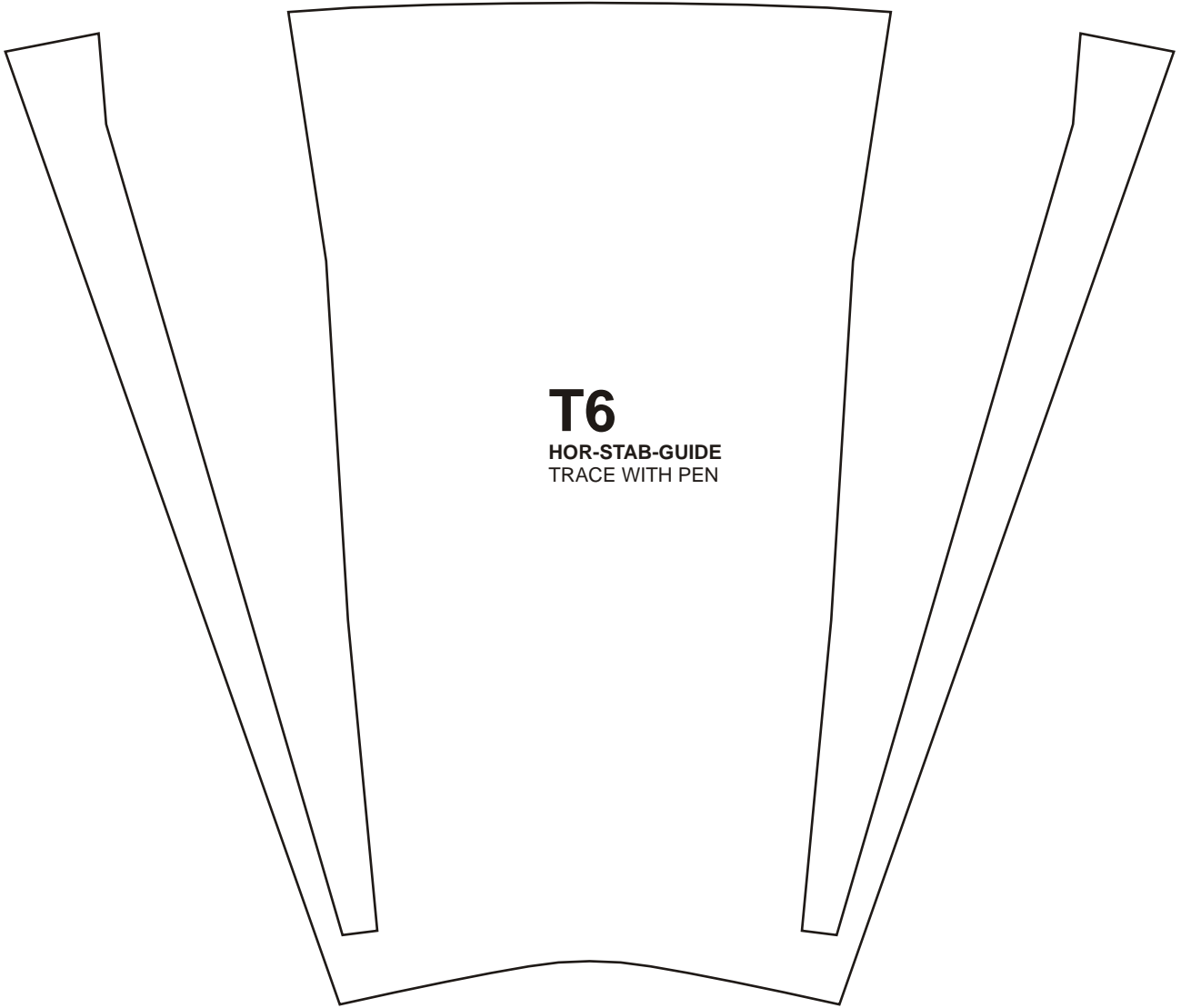

**T6**

HOR-STAB-GUIDE  
TRACE WITH PEN

**S3**

**HOR-STAB-FORMER**  
POLYFOAM/  
DEPRON 5MM2X MIRRORED

**S1**

**HOR-STAB-BOTTOM**  
POLYFOAM/  
DEPRON 5MM  
2X MIRRORED

JOIN HERE

JOIN HERE

S1

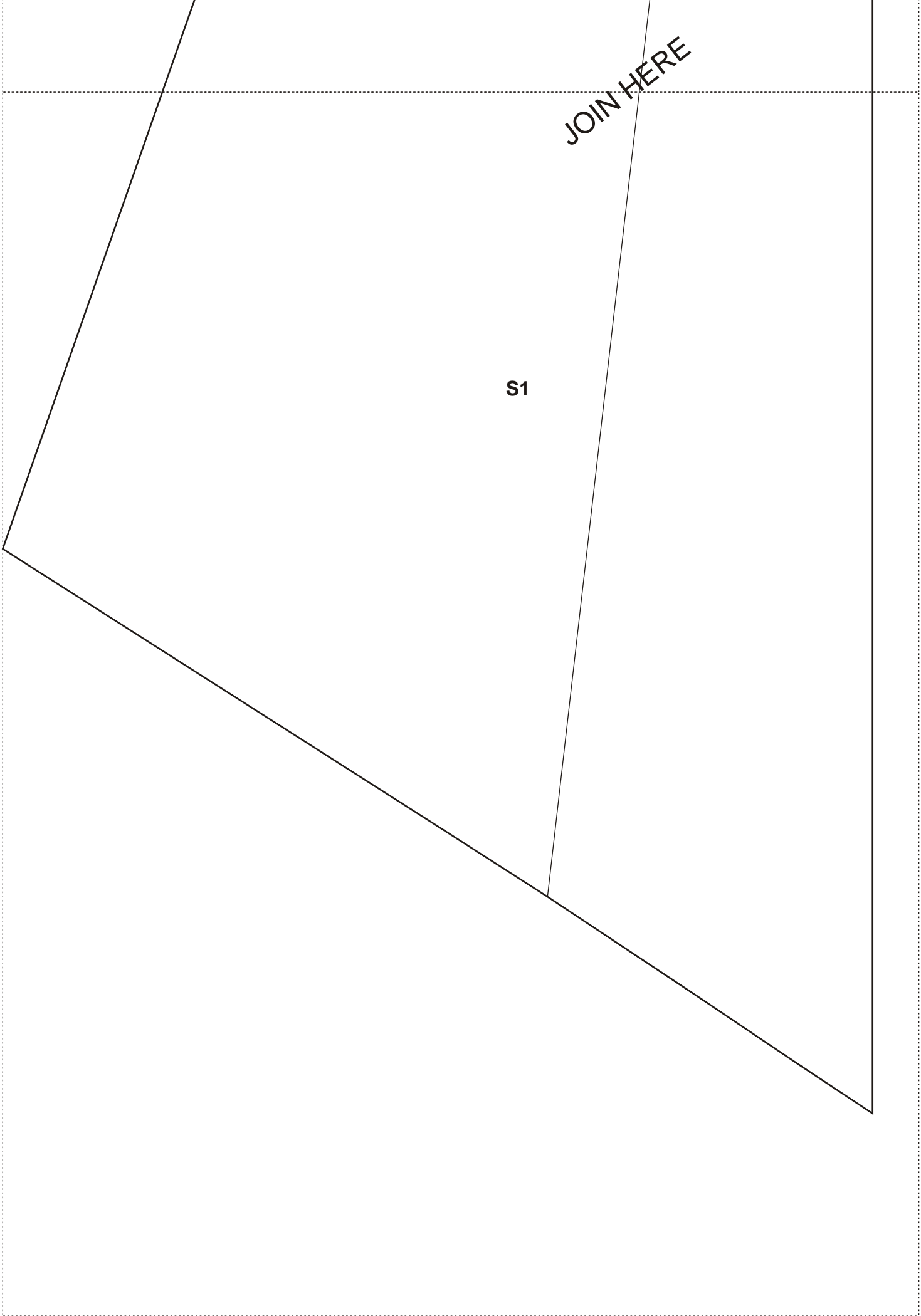

JOIN HERE

**S4**

HOR-STAB-TOP  
POLYFOAM/  
DEPRON 5MM  
2X MIRRORED

**S3**

HOR-STAB-SPAR  
POLYFOAM/ DEPRON 5MM  
2X MIRRORED

JOIN HERE

JOIN HERE

S3 JOIN HERE

S4



**T5**

**HOR-STAB-GUIDE**  
TRACE WITH PEN



**S5**

VER-STAB  
POLYFOAM/  
DEPRON 5MM  
2X MIRRORED

JOIN HERE

JOIN HERE

JOIN HERE

S5

JOIN HERE

**S6**  
VER-STAB  
SPAR  
POLYFOAM/  
DEPRON 5MM

JOIN HERE

JOIN HERE

S5

JOIN HERE

JOIN HERE

JOIN HERE

JOIN HERE

S5

S6

**S7**  
VER\_STAB  
PLYWOOD 3MM



**S8**

VER-STAB  
0.3 MICA PLASTIC

JOIN HERE

**E2**

**DUMMY ENGINE**  
POLYFOAM/ DEPRON 5MM  
2X

JOIN HERE

**E1**

**DUMMY ENGINE**  
POLYFOAM/ DEPRON 5MM  
2X

JOIN HERE

**E2**

**DUMMY ENGINE**  
POLYFOAM/ DEPRON 5MM  
2X

JOIN HERE

**E2**

JOIN HERE

JOIN HERE

**E1**

JOIN HERE

JOIN HERE

**E3**

JOIN HERE

**E2**

JOIN HERE

**E1**

**E14**

**E4**

**DUMMY ENGINE**  
MICA PLASTIC 0.3 MM  
2X





**E7**

DUMMY ENGINE  
DEPRON/POLYFOAM 5MM  
2X MIRRORED

JOIN HERE

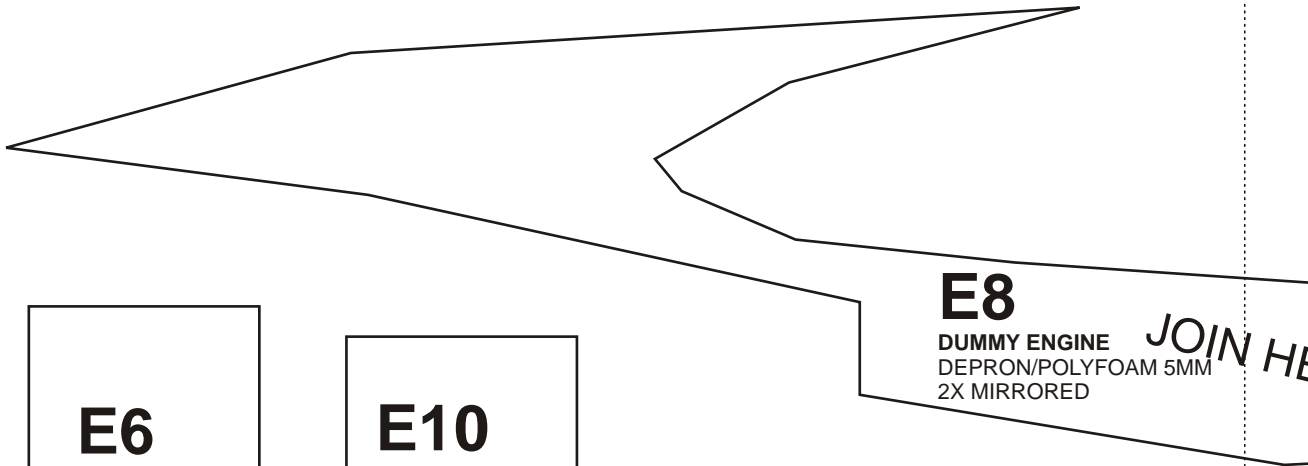

**E8**

DUMMY ENGINE  
DEPRON/POLYFOAM 5MM  
2X MIRRORED

JOIN HERE

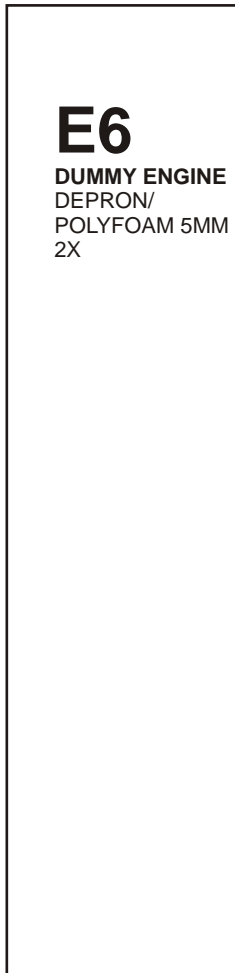

**E6**

DUMMY ENGINE  
DEPRON/  
POLYFOAM 5MM  
2X

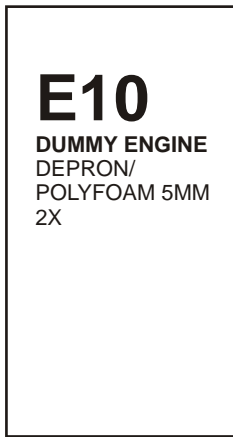

**E10**

DUMMY ENGINE  
DEPRON/  
POLYFOAM 5MM  
2X



**E9**

DUMMY ENGINE  
DEPRON/  
POLYFOAM 5MM  
2X

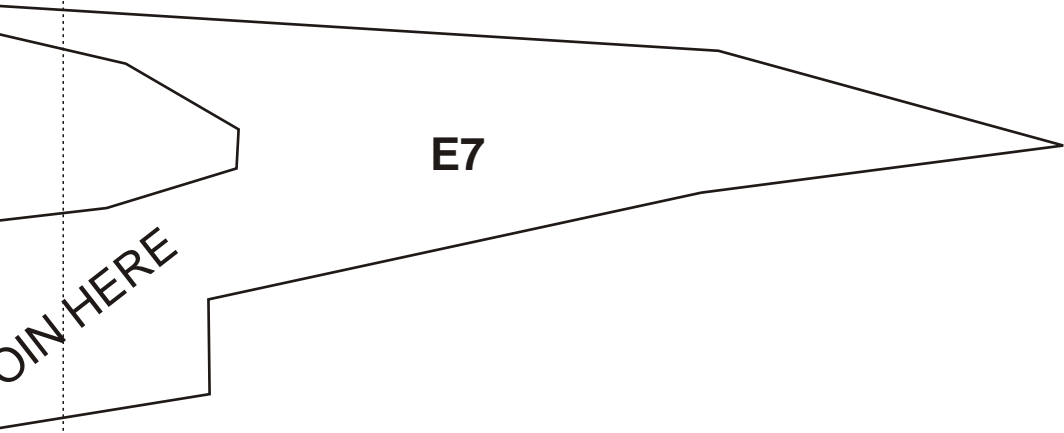

**E7**

JOIN HERE

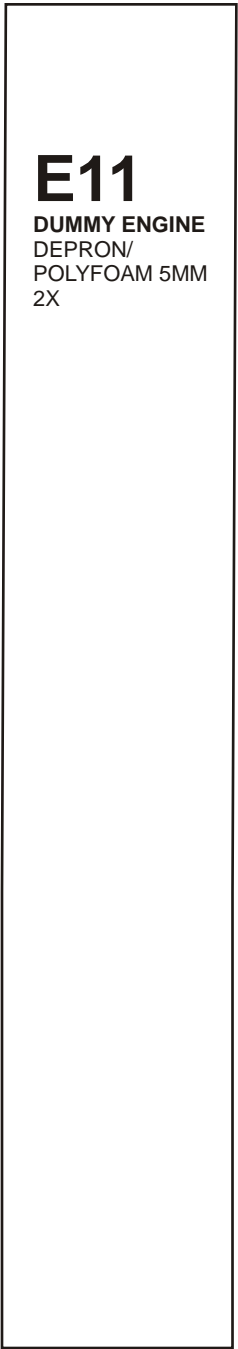

**E11**

DUMMY ENGINE  
DEPRON/  
POLYFOAM 5MM  
2X

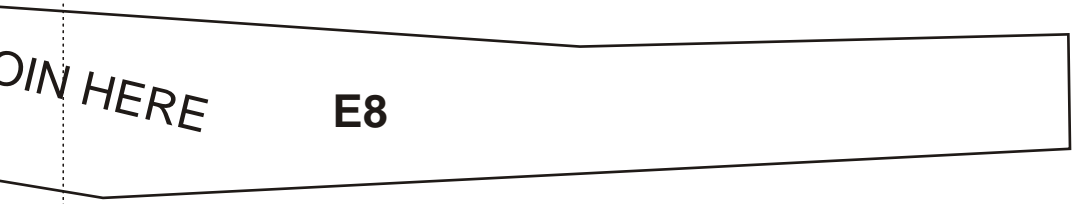

**E8**

JOIN HERE



**W16**

FLAP HINGE FAIRING  
DEPRON/  
POLYFOAM 5MM  
4X

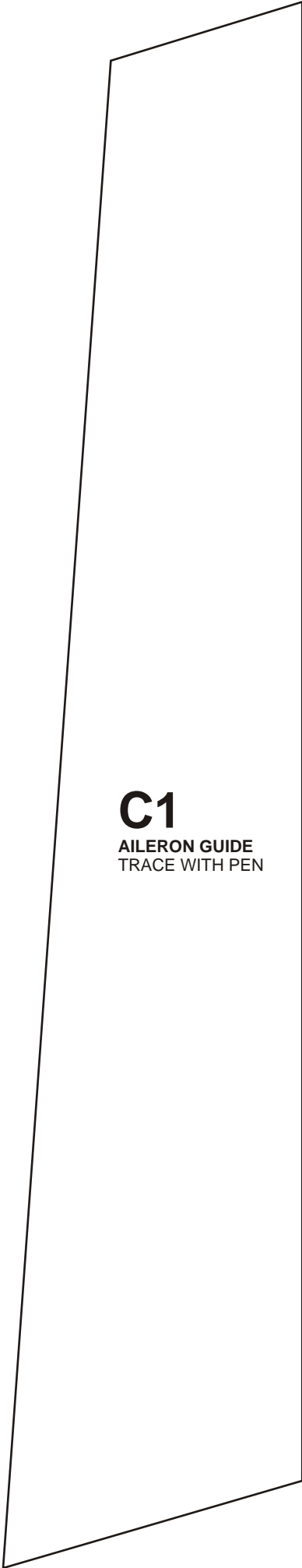

**C1**  
AILERON GUIDE  
TRACE WITH PEN

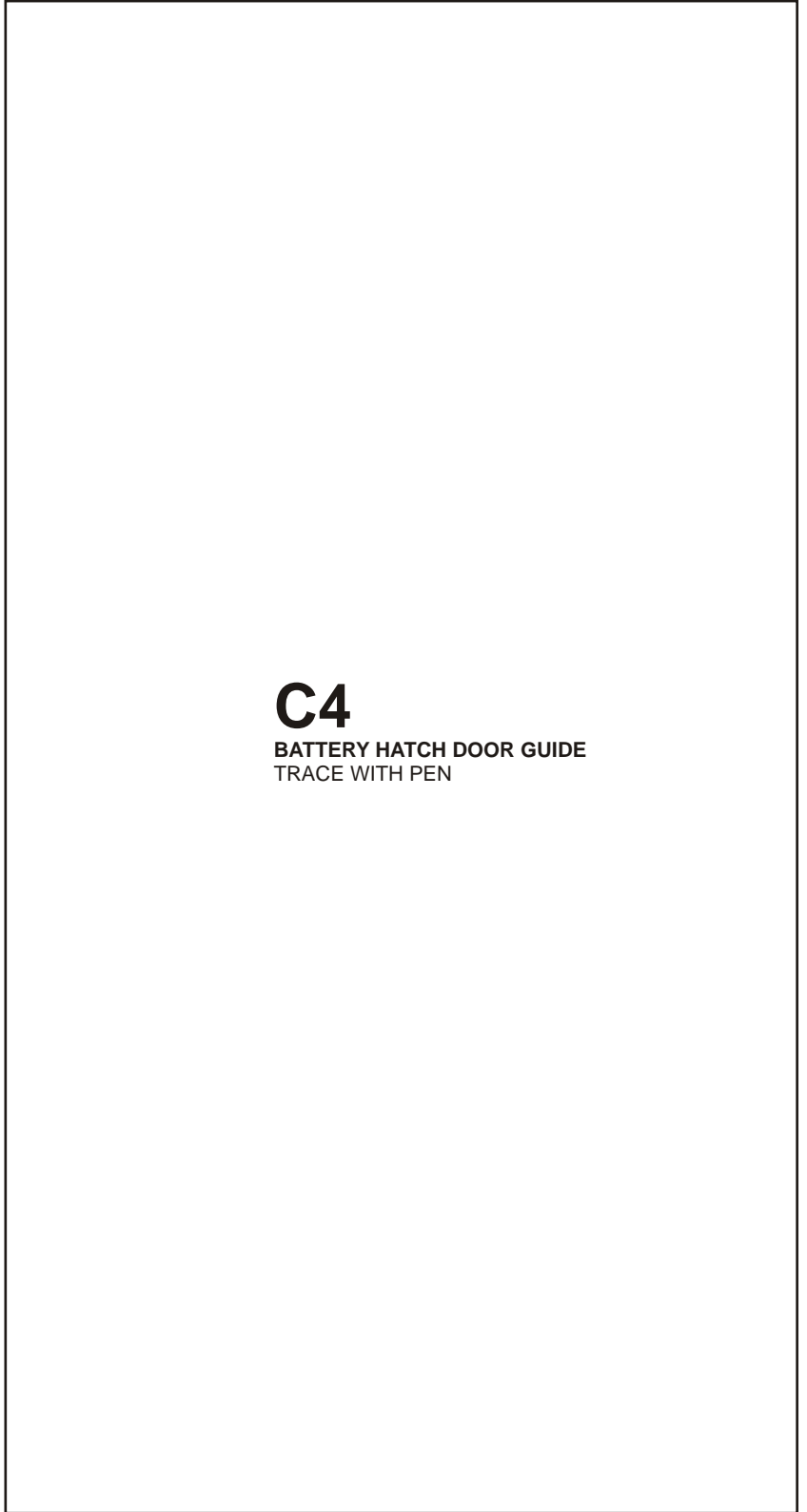

**C4**  
BATTERY HATCH DOOR GUIDE  
TRACE WITH PEN

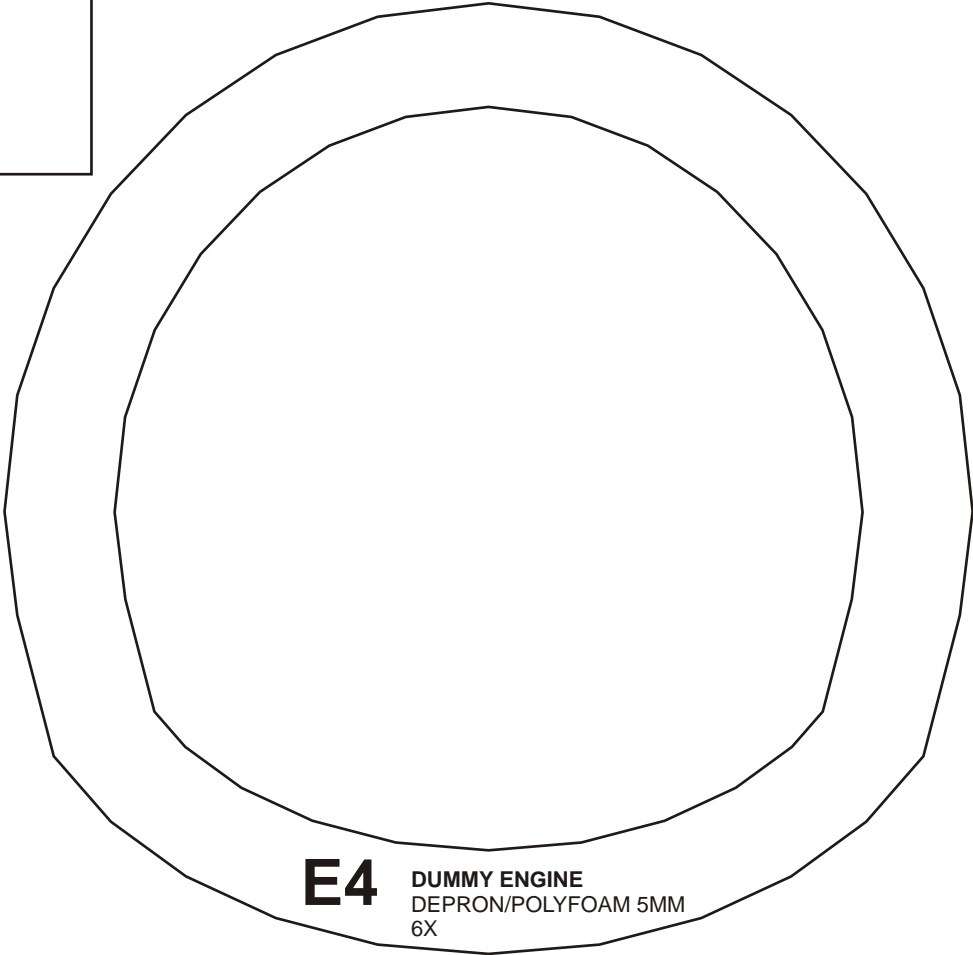
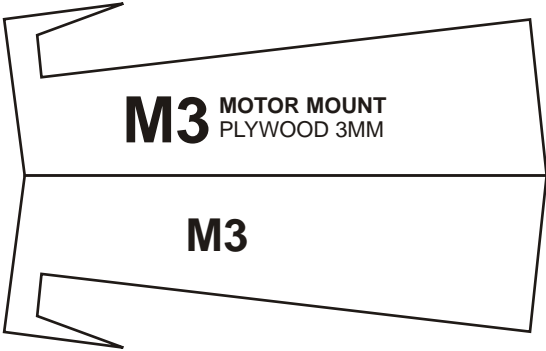
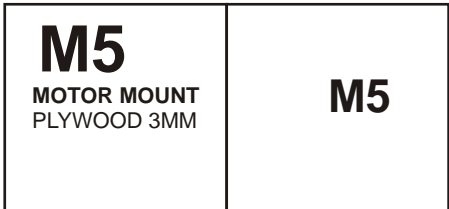
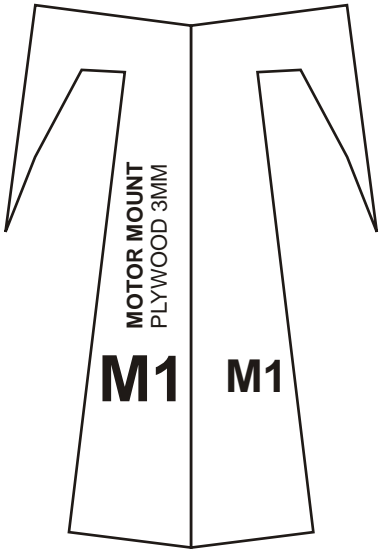
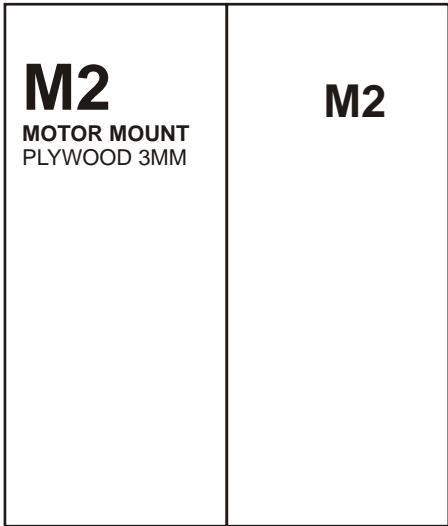
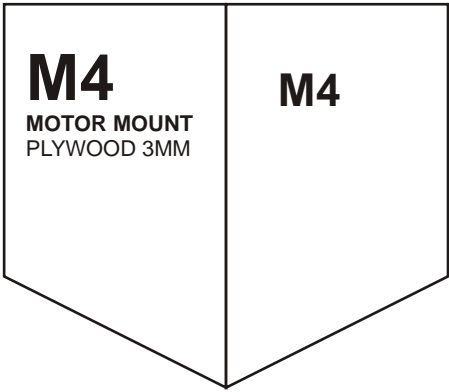

JOIN HERE

**C2**

**C2**  
RUDDER GUIDE  
TRACE WITH PEN

JOIN HERE



**C3**

**ELEVATOR GUIDE**  
TRACE WITH PEN