



## Rosalia Indah Bus Papercraft

One of intercity interprovince bus in Indonesia, under Rosalia Indah corporate this bus served on java island route. The idea to make this bus papercraft appear when I go to my first cousin house on Salatiga city (Center Java), one night trip from Bekasi city( West Java) by this bus.



This is FREE MODEL not for sale

Please read assembly instructions before cut the pattern.

Use sharp cutter and ruler to cut.

Bacalah petunjuk perakitan sebelum memotong pola

Gunakan alat pemotong yg tajam dan penggaris

legend / tanda	
	Glue / lem
	Hole/ lubang

 Paper material  
For  
**Green Environment**



Design by Rino Liha  
rino\_Gmaker4@yahoo.com

**ASSEMBLY INSTRUCTION**  
**PETUNJUK PERAKITAN**

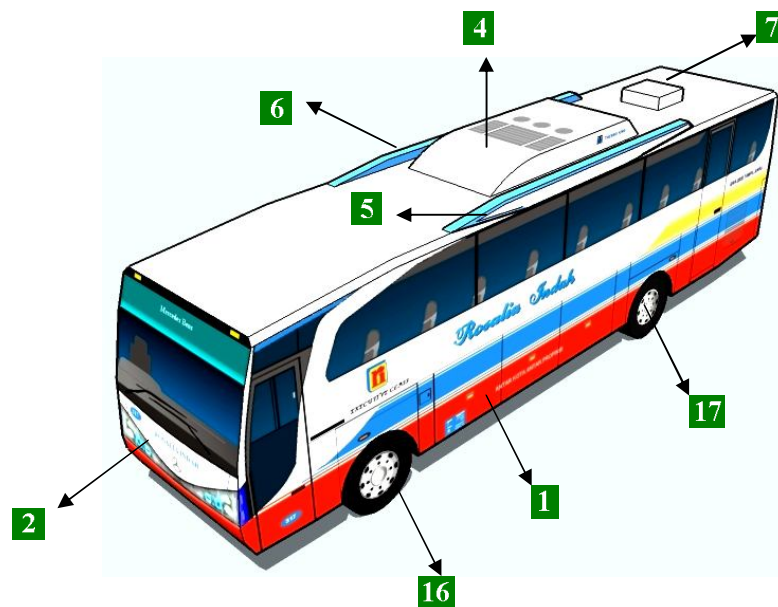
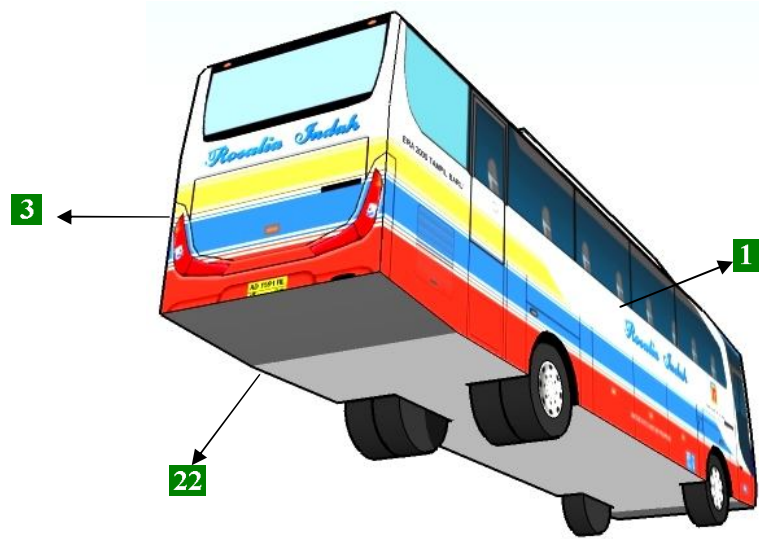
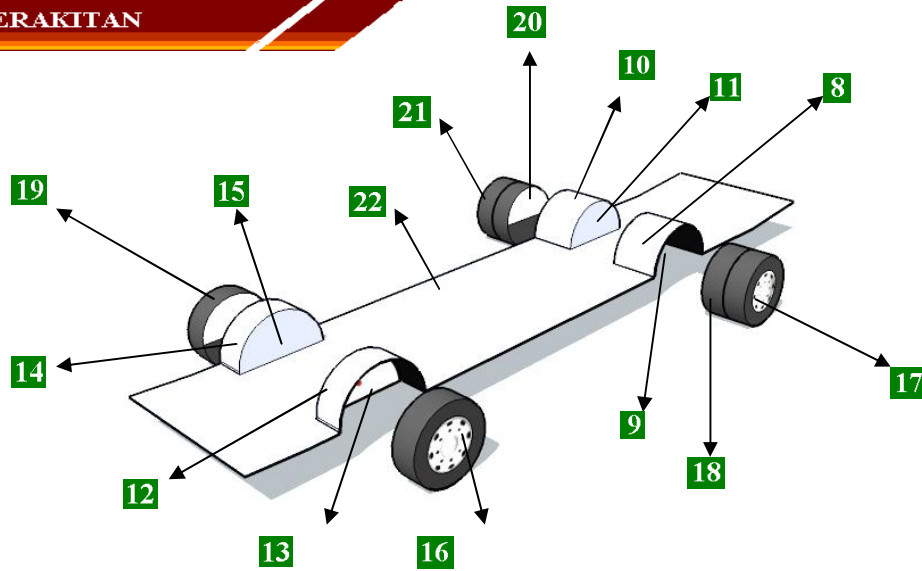

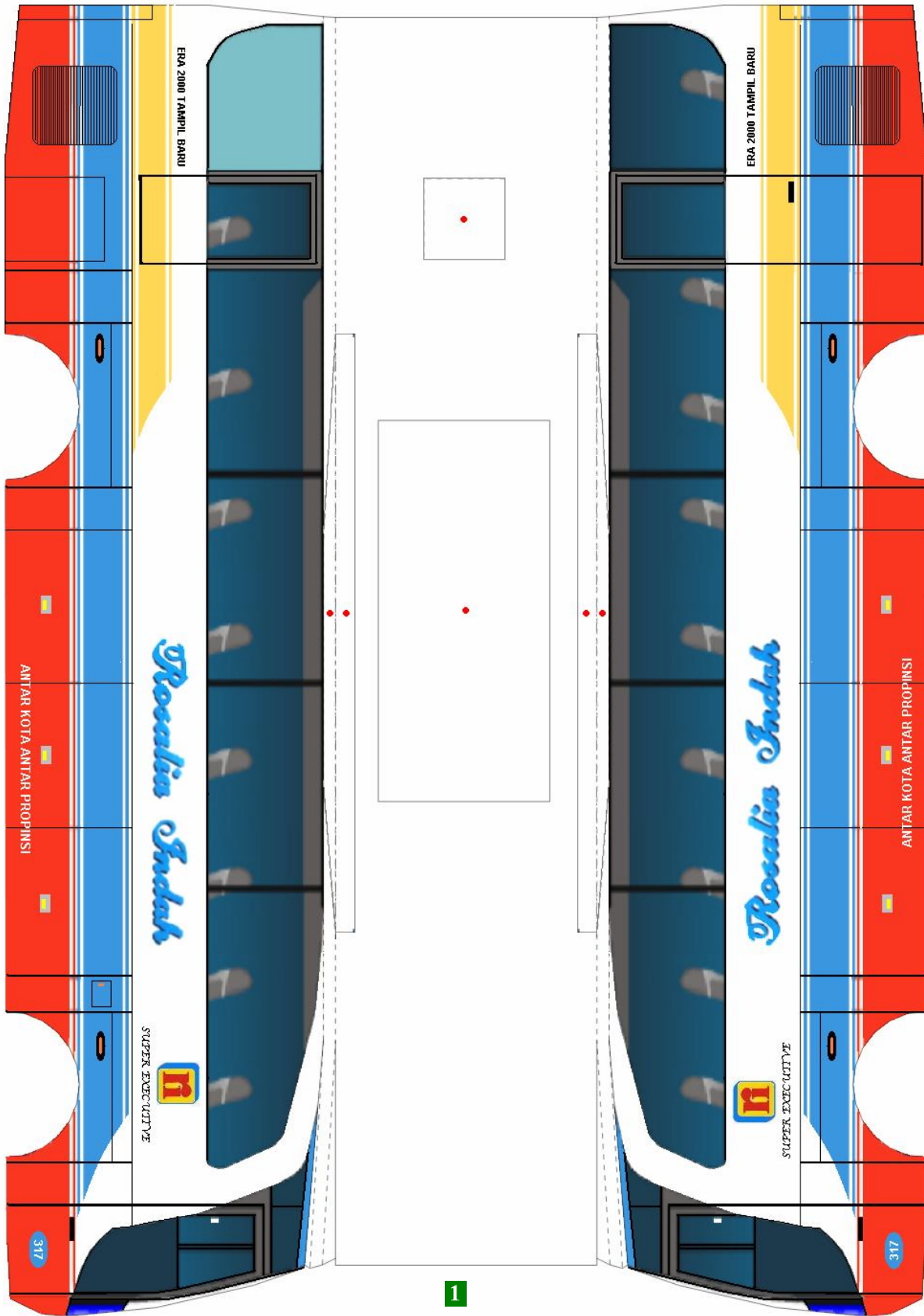

1

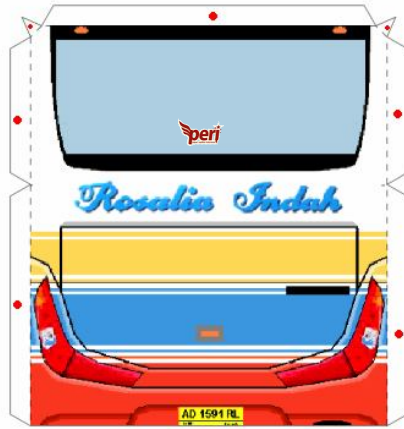
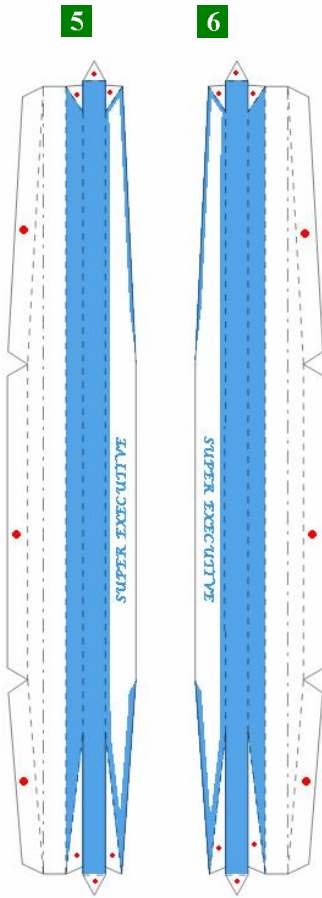

3



2

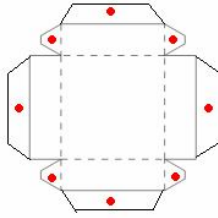

7



8

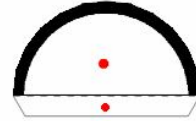

9



10

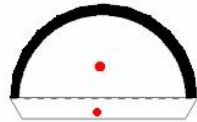

11

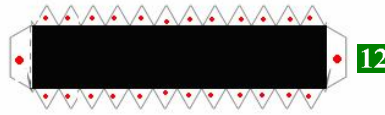

12

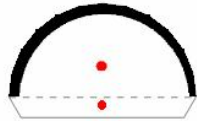

13

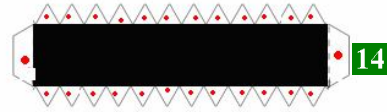

14

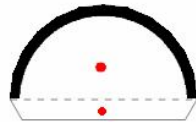

15

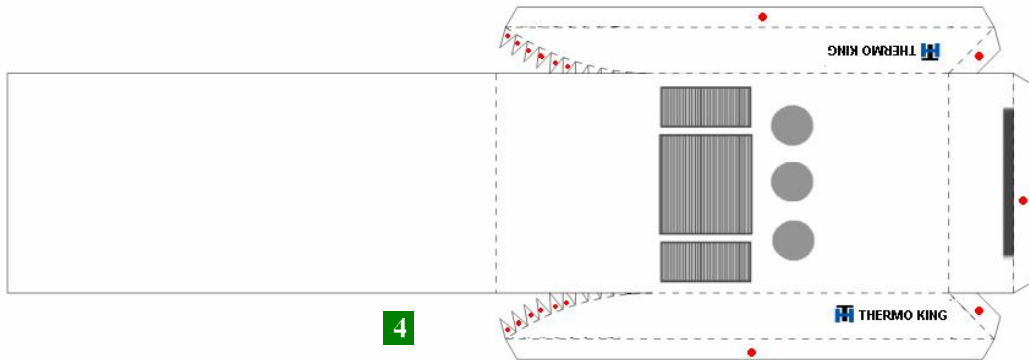

4

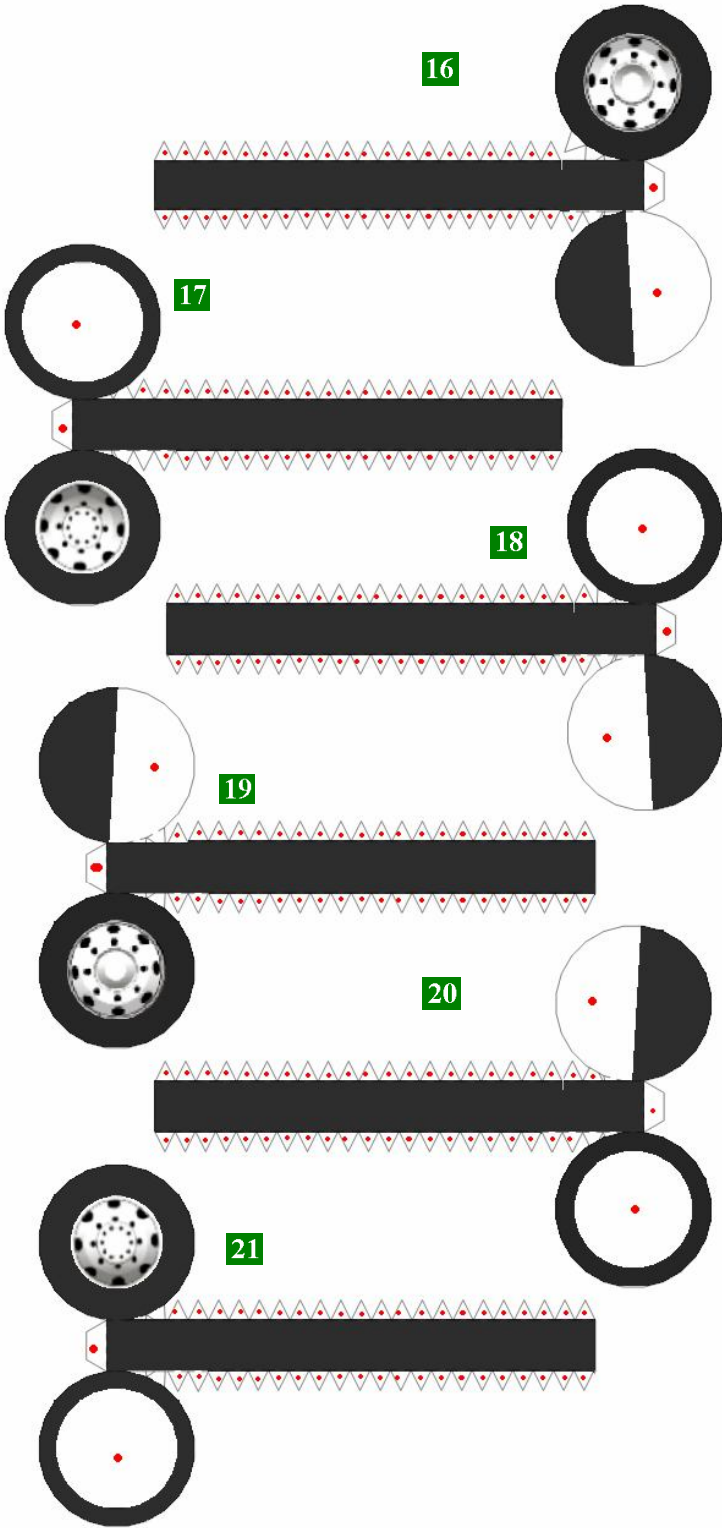

design by:  
[rino\\_gmaker4@yahoo.com](mailto:rino_gmaker4@yahoo.com)

free model, not for sale

**peri**  
 Paper Ngibika Indonesia  
 PERIBERTAS.COM